

CME 2 User Guide



P/N CC95-00454-000

Revision A
June 2009

CME 2 User Guide

TABLE OF CONTENTS

About This Manual	5
1: Introduction	7
1.1: Host Computer Requirements	8
1.2: Amplifier Commissioning Software	9
1.3: Servo Operating Modes and Control Loops	10
2: Installation, Startup, and Interface Tour	11
2.1: Install CME 2 Software	12
2.2: Start CME 2 Software	13
2.3: Configure Serial Port Parameters	14
2.4: Configure CAN Network Parameters	16
2.5: Connect to an Amplifier in CME 2	17
2.6: Rename an Amplifier	17
2.7: CME 2 Interface Tour	18
3: Amplifier Setup Procedure	23
3.1: Warnings and Notes	24
3.2: Setup Procedure	25
4: Basic Setup	29
4.1: Change Basic Setup Settings	30
4.2: Motor Options	31
4.3: Feedback Options	32
4.4: Operating Mode Options	33
4.5: Miscellaneous Options	33
4.6: ServoTube Setup	34
5: Motor/Feedback	37
5.1: Motor/Feedback Screen Overview	38
5.2: Load Motor/Feedback/Brake Settings from a File	39
5.3: Rotary Motor Setup Parameters	40
5.4: Linear Motor Setup Parameters	41
5.5: Feedback Parameters, Rotary	42
5.6: Feedback Parameters, Linear	43
5.7: Feedback Notes	44
5.8: Brake/Stop Parameters	45
5.9: Brake/Stop Notes	45
5.10: The Calculate Function	46
6: Digital Inputs and Outputs	47
6.1: Digital Inputs	48
6.2: Digital Outputs	50
6.3: Synchronizing PWM Switching Frequency	56
7: Command Inputs	57
7.1: Analog Command Settings	58
7.2: PWM Input Settings	60
7.3: Digital Position Input Settings	62
7.4: Software Programmed Input Settings	65
8: CAN Network Configuration	67
9: Faults	69
9.1: Fault Configuration Parameters	70
9.2: Fault Latching Notes	71
9.3: Position and Velocity Error Notes	72
10: Motor Phasing	75
10.1: Phase Motor with Auto Phase	76
10.2: Guidelines for Choosing Auto Phase Current and Increment Rate Values	85
10.3: Trouble Shoot the Auto Phase Process	85
10.4: Phase Motor Manually	86
10.5: Trouble Shoot Manual Phase w/ Encoder and Halls	91
11: Control Loops	93
11.1: Current Loop Setup and Tuning	94
11.2: Current Loop Auto Tune	97
11.3: Notes on the Current Mode and Current Loop	100
11.4: Velocity Loop Setup and Tuning	102
11.5: Notes on the Velocity Mode and Velocity Loop	104
11.6: Position Loop Setup and Tuning	106
11.7: Notes on the Position Mode and Position Loop	113
11.8: Auto Tune all Loops for Linear Motors	115
12: Stepper Controls	121
12.1: Stepper Motor Support	122
12.2: Position Limits (Stepper Amplifier)	123
12.3: Encoder Correction	125
12.4: Detent Compensation Gain	126
13: Homing	127
14: Control Panel	129

- 14.1: Control Panel Overview 130
- 14.2: Status Indicators and Messages 130
- 14.3: Control Panel Monitor Channels 131
- 14.4: Control Functions 132
- 14.5: Jog Mode 133
- 15: Scope Tool 135**
 - 15.1: Scope Tool Overview 136
 - 15.2: Function Generator and Profile Tabs 137
 - 15.3: Trace Channel Variable Parameters 138
 - 15.4: Trigger Setup 139
 - 15.5: Trace Time, Sample Rate and Single Trace 140
 - 15.6: Scope Display Parameters 140
 - 15.7: Auto Setup 141
 - 15.8: Measurement Tab 142
 - 15.9: Control Loop Parameters 143
 - 15.10: Scope Files 145
- 16: Data, Firmware, and Logs 149**
 - 16.1: Amplifier RAM and Flash Memory 150
 - 16.2: Disk Storage of Amplifier and Motor Data Files 150
 - 16.3: Data Management Tools 151
 - 16.4: Amplifier Firmware 153
 - 16.5: Error Log 155
 - 16.6: Communications Log 156
- 17: Virtual Amplifier 157**
- A: Copy Amplifier Data 159**
- B: Lock/Unlock CME 2 Controls 161**
- C: I²T Time Limit Algorithm 163**
 - C.1: I²T Algorithm 164
 - C.2: I²T Scope Trace Variables 167
- D: Low-Pass and Bi-Quad Filters 169**
- E: Homing Methods 171**
 - E.1: Homing Methods Overview 172
 - E.2: Legend to Homing Method Descriptions 172
 - E.3: Homing Method Descriptions 173
- F: Regen Resistor Configuration 187**
- G: ASCII Commands/Serial Control 189**
 - G.1: Copley ASCII Interface 190
 - G.2: CME 2 ASCII Command Line Interface Tool 190
 - G.3: Single-Axis Serial Connection 191
 - G.4: Multi-Drop Serial Connection 191
- H: Gain Scheduling 193**
 - H.1: Configure Gain Scheduling 194
 - H.2: Set Up the Gain Scheduling Table(s) 195
 - H.3: Gain Scheduling Table Guidelines 199

ABOUT THIS MANUAL

Overview and Scope

This manual describes the installation and use of Copley Controls CME 2 software.

Related Documentation

CANopen-related documents:

- *CANopen Programmer's Manual*
- *CML Reference Manual*
- *Copley Motion Objects Programmer's Guide*

DeviceNet-related:

- *Copley DeviceNet Programmer's Guide*

Also of related interest:

- *Copley Indexer 2 Program User Guide* (describes use of Indexer 2 Program to create motion control sequences)
- *Copley ASCII Interface Programmer's Guide* (describes how to send ASCII format commands over an RS232 serial bus to control one or more amplifiers)
- *Copley Camming User Guide* (describes the use of the Copley Controls Camming feature, and its setup through CME 2)
- *Copley Amplifier Parameter Dictionary* (describes the parameters used to program and operate Copley Controls amplifiers)

Links to these publications, along with hardware manuals and data sheets, can be found under the *Documents* heading at:

<http://www.copleycontrols.com/Motion/Downloads/index.html>

Copley Controls software and related information can be found at:

<http://www.copleycontrols.com/Motion/Products/Software/index.html>

Comments

Copley Controls welcomes your comments on this manual. See

<http://www.copleycontrols.com> for contact information.

Copyrights

No part of this document may be reproduced in any form or by any means, electronic or mechanical, including photocopying, without express written permission of Copley Controls.

CME 2, Copley Virtual Machine, CVM, Xenus, Accelnet, Stepnet, Accelus, and Junus are registered trademarks of Copley Controls.

Windows NT, 2000, XP, and Vista are trademarks or registered trademarks of the Microsoft Corporation.

Document Validity

We reserve the right to modify our products. The information in this document is subject to change without notice and does not represent a commitment by Copley Controls.

Copley Controls assumes no responsibility for any errors that may appear in this document.

1.1.1: Product Warnings

Observe all relevant state, regional, and local safety regulations when installing and using Copley Controls amplifiers. For safety and to assure compliance with documented system data, only Copley Controls should perform repairs to amplifiers.



DANGER

Hazardous voltages.

Exercise caution when installing and adjusting Copley amplifiers.

Risk of electric shock.

On some Copley Controls amplifiers, high-voltage circuits are connected to mains power. Refer to hardware documentation.

Risk of unexpected motion with non-latched faults.

After the cause of a non-latched fault is corrected, the amplifier re-enables the PWM output stage without operator intervention. In this case, motion may re-start unexpectedly. Configure faults as latched unless a specific situation calls for non-latched behavior. When using non-latched faults, be sure to safeguard against unexpected motion.

Latching an output does not eliminate the risk of unexpected motion with non-latched faults.

Associating a fault with a latched, custom-configured output does not latch the fault itself. After the cause of a non-latched fault is corrected, the amplifier re-enables without operator intervention. In this case, motion may re-start unexpectedly.

For more information, see [Faults \(p. 69\)](#).

When operating the amplifier as a CAN or DeviceNet node, the use of CME 2 or ASCII serial commands may affect operations in progress. Using such commands to initiate motion may cause network operations to suspend.

Operation may restart unexpectedly when the commanded motion is stopped.

Use equipment as described.

Operate amplifiers within the specifications provided in the relevant hardware manual or data sheet.

FAILURE TO HEED THESE WARNINGS CAN CAUSE EQUIPMENT DAMAGE, INJURY, OR DEATH.

1.1.2: Revision History

Revision	Date	ECO #	Applies to	Comments
1	February 2006		CME 2 Software version 4.1. Firmware version 4.66 or higher.	Initial publication. Adapted from <i>Xenus User's Guide v2.0</i> .
2	August 2006		CME 2 Software version 4.2. Firmware version 5.04 or higher.	Various changes.
3	June 2007	15383	CME 2 Software version 5.0.	Changes include new Auto Tune all Loops for Linear Motors (p. 115) and a new way to Change Basic Setup Settings (p. 30) .
4	June 2008	16709	CME 2 Software version 5.1.	Changes include the new scope tool Measurement Tab (p. 142) , Gain Scheduling (p. 193) , and Velocity Gains Shift (p. 105) .
A	June 2009	33392	CME 2 Software version 5.2	Various changes.

CHAPTER

1: INTRODUCTION

This chapter describes the basic functions and operational theory of CME 2. Topics include:

-
- ✓ [Host Computer Requirements \(p. 8\)](#).
 - ✓ [Amplifier Commissioning Software \(p. 9\)](#).
 - ✓ [Servo Operating Modes and Control Loops \(p. 10\)](#).
-

1.1: Host Computer Requirements

1.1.1: Computer and Operating System

Minimal hardware requirements:

- **CPU:** 400 MHZ.
- **RAM:** 128 MB.

Operating Systems Supported: Windows NT, 2000, XP.

Vista users see [Special Notes for Vista Users](#) (p. 8).

1.1.2: Special Notes for Vista Users

Windows Vista is supported in this version of CME 2.

Note that when the installer starts, a message will be displayed stating that an unidentified program is trying to access the computer. Click the button to allow the installer to continue, and CME 2 will be installed properly.

On previous versions of Windows, the user data for CME 2 (like ccx, ccm, files, etc.) were stored in C:\Program Files\Copley Motion\CME 2. Because of Windows Vista security, the CME 2 user files are stored on Vista systems in C:\Users\Public\Public Documents\Copley Motion\CME 2.

1.1.3: Software

Copley Controls CME 2 software, Version 5.2 or higher.

1.1.4: Serial Communications

For each PC-to-amplifier connection via serial port:

- One standard RS-232 serial port or a USB port with a USB-to-RS-232 adapter.
- One serial communication cable. See amplifier data sheet for part numbers.

1.1.5: CAN Communications

(Xenus, Accelnet, and Stepnet only.)

- One Copley Controls CAN PCI network card (part number CAN-PCI-02). CME 2 also supports CAN network cards made by these manufacturers: KVaser, Vector, and National Instruments.
- One PC-to-amplifier CANopen network cable. See amplifier data sheet for part numbers.

See the amplifier data sheet for CAN network wiring instructions.

1.2: Amplifier Commissioning Software

Copley Controls CME 2 software allows fast and easy commissioning of Copley Controls amplifiers. It provides access to all amplifier configuration controls. It supports all Copley Controls amplifiers, including Copley's CANopen amplifier lines and stepper amplifiers.

CME 2 communicates with amplifiers via RS-232 or CAN connections. On Xenus, Accelnet, and Stepanet amplifiers, the multi-drop feature allows CME 2 to use a single RS-232 serial connection to one amplifier as a gateway to other amplifiers linked together by CAN bus or DeviceNet connections.

Motor data can be saved as *.ccm* files. Amplifier data is saved as *.ccx* files that contain all amplifier settings plus motor data. This makes it possible to quickly set up amplifiers by copying configurations from one amplifier to another.

CME 2 also provides access to Copley Virtual Machine (CVM), a program that is set up in CME 2 and downloaded to the amplifier to provide on-board control. When a CVM program is running, the amplifier receives its input commands from the CVM program. For more information, see the *Copley Indexer 2 Program User's Guide*.

NOTE: The feature descriptions in this manual may not apply to all Copley Controls amplifiers under all configurations. Significant differences between amplifier models are noted. See the relevant hardware manual or data sheet for more information.

1.3: Servo Operating Modes and Control Loops

Copley Controls amplifiers use up to three nested control loops - current, velocity, and position - to control a motor in three associated operating modes. (Stepper amplifiers operated in stepper mode function as traditional open position loop stepper drives.)

Control Loops Model

In position mode, the amplifier uses all three loops. As shown in the typical system illustrated below, the position loop drives the nested velocity loop, which drives the nested current loop.

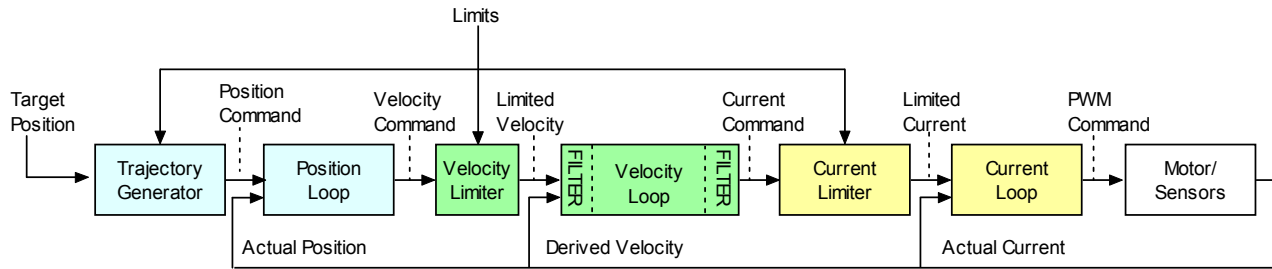

In velocity mode, the velocity loop drives the current loop. In current mode, the current loop is driven directly by external or internal current commands.

Basic Attributes of All Servo Control Loops

These loops share several common attributes:

Loop Attribute	Description
Command input	Every loop is given a value to which it will attempt to control. For example, the velocity loop receives a velocity command that is the desired motor speed.
Limits	Limits are set on each loop to protect the motor and/or mechanical system.
Feedback	The nature of servo control loops is that they receive feedback from the device they are controlling. For example, the position loop uses the actual motor position as feedback.
Gains	These are constant values that are used in the mathematical equation of the servo loop. The values of these gains can be adjusted during amplifier setup to improve the loop performance. Adjusting these values is often referred to as <i>tuning</i> the loop.
Output	The loop generates a control signal. This signal can be used as the command signal to another control loop or the input to a power amplifier.

For more information on using CME 2 to set up and tune control loops, see [Control Loops \(p. 93\)](#).

CHAPTER

2: INSTALLATION, STARTUP, AND INTERFACE TOUR

This chapter shows how to install, start, and set up communications for CME 2. Perform the steps outlined below. Details follow in the chapter.

- 1 Verify that the system on which you will install CME 2 meets the [Host Computer Requirements \(p. 8\)](#).
NOTE: Vista users see [Special Notes for Vista Users \(p. 8\)](#).
- 2 [Install CME 2 Software \(p. 12\)](#).
- 3 [Start CME 2 \(p. 13\)](#).
- 4 [Configure Serial Port Parameters \(p. 14\)](#) or [Configure CAN Network Parameters \(p. 16\)](#).

(To set up for DeviceNet control, see the Copley Controls *Copley DeviceNet Programmer's Guide*.)

The chapter also includes [CME 2 Interface Tour \(p. 18\)](#) and describes how to [Connect to an Amplifier in CME 2 \(p. 17\)](#) and [Rename an Amplifier \(p. 17\)](#).

2.1: Install CME 2 Software

Optionally download software from the Web

- 1 Choose or create a folder where you will download the software installation file.
 - 2 In an internet browser, navigate to:
<http://www.copleycontrols.com/Motion/Downloads/index.html>
 - 3 Under *Software Releases*, click on *CME 2*.
 - 4 When prompted, save the *CME2.zip* file to the folder chosen or created in Step 1. The folder should now contain a file named *CME2.zip*.
 - 5 Extract the contents of the zip file to the same location. The folder should now contain the files *CME2.zip* and *Setup.exe*.
 - 6 If desired, delete *CME2.zip* to save disk space.
-

Install CME 2 Software

- 1 If installing from a CD, insert the CD (Copley Controls part number *CME2*). Normally, inserting the CD causes the installation script to launch, and a CME 2 Installation screen appears. If so, skip to Step 3.
 - 2 If the software installation file is on a hard drive, navigate to the folder and then double-click on *Setup.exe*
OR
if you inserted the CD and the CME 2 *Installation* screen did not appear, navigate to the root directory of the installation CD and then double-click on *Setup.exe*.
 - 3 Respond to the prompts on the CME 2 *Installation* screens to complete the installation. We recommend accepting all default installation values.
NOTE: Vista users see [Special Notes for Vista Users \(p. 8\)](#).
-



2.2: Start CME 2 Software

1

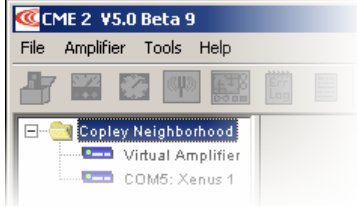

Double-click the CME 2 shortcut icon on the Windows desktop to start CME 2.

2

If communications were set up already...	If communications were not set up...
<p>...the CME 2 Main Screen opens. If there are multiple ports, the Copley Neighborhood root will be selected as shown below:</p>  <p>Select the desired amplifier. For instance:</p>  <p>See Connect to an Amplifier (p. 17).</p>	<p>...see the screen below:</p>  <p>In this case, proceed to Configure Serial Port Parameters (p. 14) or Configure CAN Network Parameters (p. 16).</p> <p>If the amplifier is to run under DeviceNet control, select Serial Ports. For more information, see the <i>Copley DeviceNet Programmer's Guide</i>.</p>

After an amplifier has been selected, the CME 2 Main Screen looks similar to this:

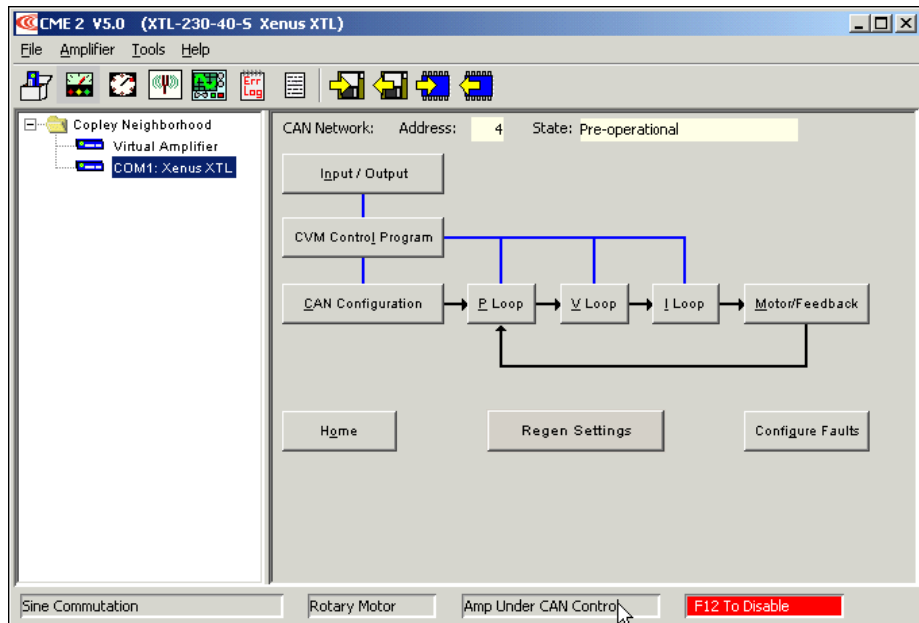

If the Basic Setup options have not been chosen, the *Basic Setup* screen opens.

2.3: Configure Serial Port Parameters

One or more serial ports on a PC can be used to connect amplifiers. Use the following instructions to add ports for amplifiers, to choose baud rates for those ports, and to remove ports for amplifiers.

Also use this procedure if the amplifier is to run under DeviceNet control. For more information, see the Copley Controls *Copley DeviceNet Programmer's Guide*.



- 1 Double-click the CME 2 shortcut icon on the Windows desktop to start CME 2.

If a serial or CAN port has not been selected, the *Communications Wizard Select device* screen appears.



- 2 If the CME 2 *Main* screen appears instead of *Select Device*, choose **Tools**→**Communications Wizard**.
- 3 Choose **Serial Ports** and click **Next** to open the *Communications Wizard Select Ports/Serial Ports* screen.

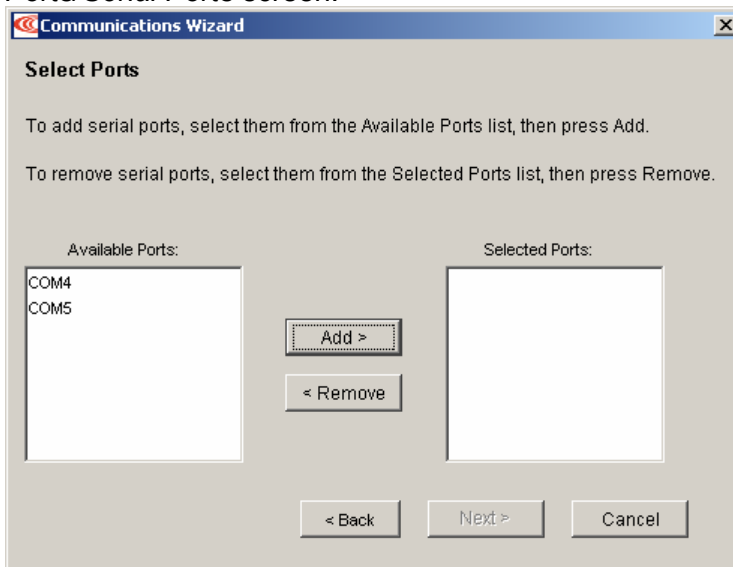

- 4 From the *Available Ports* list, choose the serial ports that will be used for amplifiers.
 - To allow an amplifier to connect through a port, select the port name and click **Add**.
 - To remove a port from *Selected Ports*, select the port name and click **Remove**.

Continued...

...Configure Serial Port Parameters, continued:

- 5 Click **Next** to save the choices and open the *Communications Wizard Configure Serial Ports* screen.

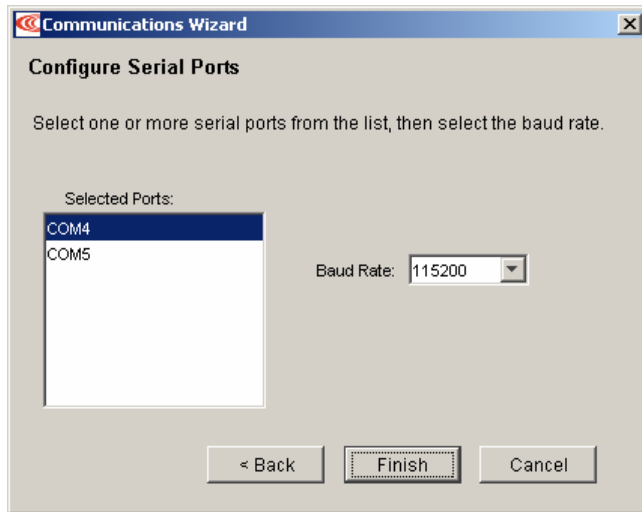

- 6 Configure the desired ports.
- Highlight a port in the *Selected Ports* list.
 - Choose a *Baud Rate* for that port.
 - Repeat for each selected port.
- 7 Click **Finish** to save the choices.
-

2.4: Configure CAN Network Parameters

A CAN port can be used to connect the host PC to one or more amplifiers. Use the following instructions to configure CAN network settings.

- 
 Double-click the CME 2 shortcut icon on the Windows desktop to start CME 2.

If communications have not been set up, the *Communications Wizard Select device* screen appears.



- If the CME 2 *Main* screen appears choose **Tools**→**Communications Wizard**.
- Choose **CAN Network**.



- Click **Next** to open the *Communications Wizard Configure CAN Network* screen.





- Choose the appropriate **CAN Card**, **Channel**, and **Bit Rate**, and click **Finish**.

NOTES:

- The CAN Card list shows the manufacturer names of all supported CAN cards that have been connected to the PC and for which drivers have been installed.
- All amplifiers must be set to the same bit rate (default is 1 Mbit/s).

2.5: Connect to an Amplifier in CME 2

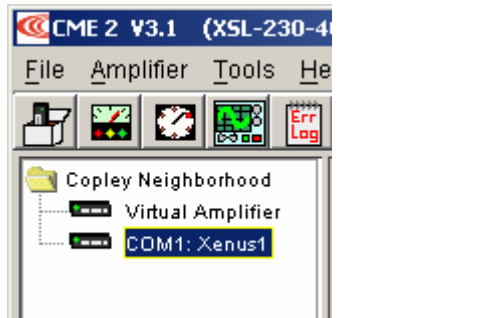
Choose an amplifier by clicking on its name in the Copley Neighborhood. The neighborhood organizes amplifiers according to the connection method.

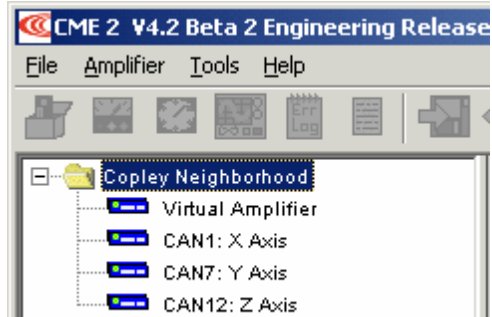
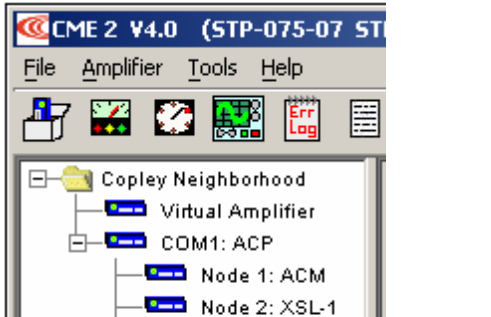
<p>One amplifier:</p> 	<p>Multiple amplifiers on serial:</p> 
<p>CAN network:</p> 	<p>Multi-drop: CAN or DeviceNet:</p> 

When there is only one amplifier available for connection, the software will connect automatically on startup.

2.6: Rename an Amplifier

Each amplifier represented in the *Copley Neighborhood* amplifier tree has a name. The default name for an amplifier is *unnamed*. Use this procedure to rename an amplifier.

- 1 Choose Main Menu **Amplifier**→**Rename** to open the *Rename Amplifier* screen.

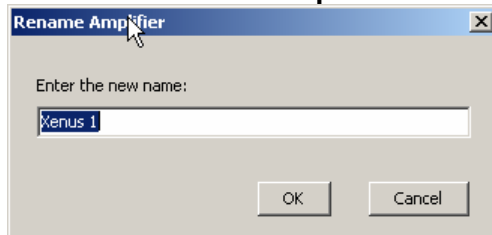

- 2 Enter the new name and click **OK** to close the screen.

2.7: CME 2 Interface Tour

CME 2 features are called out in the diagram below. Screen details vary depending on amplifier model and mode selection. Details follow in the chapter.

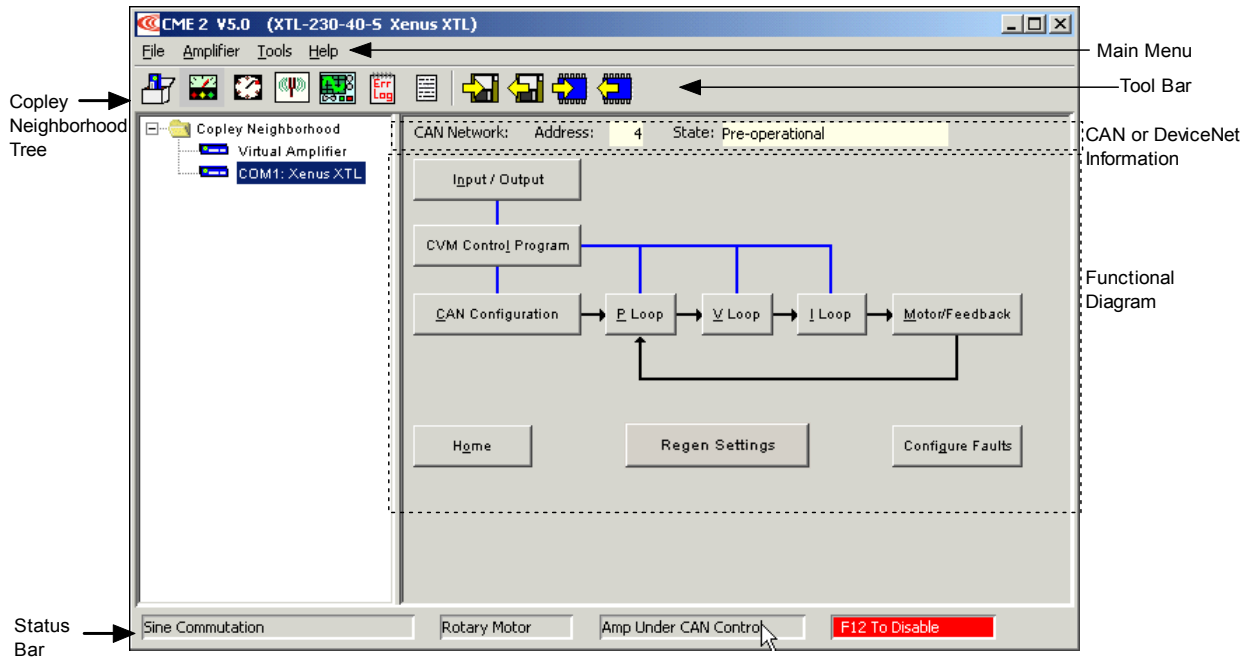

2.7.1: Tool Bar Overview

Click on any of the tools in the toolbar to access the tools described below.

Icon	Name	Description	For More Information
	Basic Setup	Opens <i>Basic Setup</i> screen.	Basic Setup (p. 29)
	Control Panel	Opens <i>Control Panel</i> .	Control Panel (p. 129)
	Auto Phase	Opens <i>Auto Phase</i> tool.	Motor Phasing (p. 75)
	Auto Tune	Opens <i>Auto Tune</i> for Linear Servo Motors.	Auto Tune all Loops for Linear Motors (p. 115)
	Scope	Opens <i>Scope</i> .	Scope Tool (p. 135)
	Error Log	Opens <i>Error Log</i> .	Error Log (p. 155)
	Amplifier Properties	Displays basic amplifier properties.	
	Save amplifier data to disk	Saves contents of amplifier RAM to a disk file.	Data, Firmware, and Logs (p. 149)
	Restore amplifier data from disk	Restores an amplifier file from disk to amplifier RAM.	
	Save amplifier data to flash	Saves contents of amplifier RAM to flash memory.	
	Restore amplifier data from flash	Restores contents of flash memory to amplifier RAM.	

2.7.2: Main Menu Overview

The CME 2 Main Menu choices are described below.

Menu	Selection	Description	For More Information
File	Save MACRO File	(MACRO amplifiers only.) Saves amplifier setup and tuning parameters in a format that can be read by Delta Tau controllers.	Save MACRO File for Delta Tau Controllers (p. 152).
	Save Amplifier Data	Saves contents of amplifier RAM to a disk file.	Data, Firmware, and Logs (p. 149).
	Save As→V4.1 Format	Saves amplifier data file in format usable by CME 2 Version 4.1.	
	Restore→Amplifier Data	Restores contents of an amplifier file from disk to amplifier RAM.	
	Restore→CVM Control Program	Prompts for a Copley Virtual Machine program file. The program in this file will replace the current program in flash. This procedure also results in the setting of the Indexer 2 Program option Enable Control Program on Startup. This configures the program to auto start when the amplifier is powered up or reset.	Copley Indexer 2 Program User Guide.
	Restore→Cam Tables	Prompts for a saved Cam Table file (.cct file). All tables in amplifier flash will be replaced by the ones in this file.	See Copley Camming Users Guide.
	Restore→Gain Scheduling Table	Prompts for a saved Gain Scheduling Table (.ccg file).	Gain Scheduling (p. 193).
	Exit	Closes CME 2.	
Amplifier	Basic Setup	Opens <i>Basic Setup</i> screen.	Basic Setup (p. 29)
	Control Panel	Opens <i>Control Panel</i> .	Control Panel (p. 129)
	Auto Phase	Opens <i>Auto Phase</i> tool.	Motor Phasing (p. 75)
	Scope	Opens <i>Scope</i> .	Scope Tool (p. 135)
	Error Log	Opens <i>Error Log</i> .	Error Log (p. 155)
	Amplifier Properties	Displays basic amplifier properties.	
	Network Configuration	Opens the CAN or DeviceNet Configuration screen.	CAN: CAN Network Configuration (p. 67). DeviceNet: Copley DeviceNet Programmer's Guide.
	Rename	Prompts for new amplifier name.	Rename an Amplifier (p. 17)
	Auto Tune	Opens <i>Auto Tune</i> for Linear Servo Motors.	Auto Tune all Loops for Linear Motors (p. 115)
	Gain Scheduling	Opens <i>Gain Scheduling</i> screen.	Gain Scheduling (p. 193).
Continued...			

...Main Menu Choices, continued:			
Menu	Selection	Description	For More Information
Tools	Communications Wizard	Starts sequence of prompts to set up communications.	Configure Serial Port Parameters (p. 14) and Configure CAN Network Parameters (p. 16) .
	Communications Log	Opens <i>Communications Log</i> .	Communications Log (p. 156) .
	Download Firmware	Starts prompts to download firmware from disk to amplifier.	Download Firmware to the Amplifier (p. 153) .
	Download CPLD Program	Starts prompts to download PLD code from disk to amplifier.	
	Manual Phase	Opens <i>Manual Phase</i> tool.	Phase Motor Manually (p. 86) .
	View Scope Files	Opens <i>Trace Viewer</i> window.	Scope Files (p. 145) .
	I/O Line States	Opens I/O Line States window, showing high/low status of the amplifier's inputs and outputs.	Digital Inputs and Outputs (p. 47) .
	CME 2 Lock/Unlock	Opens screen for locking and unlocking CME 2 functionality.	Lock/Unlock CME 2 Controls (p. 161) .
	ASCII Command Line	Opens screen to accept ASCII format commands.	CME 2 ASCII Command Line Interface Tool (p. 190) .
Help	CME 2 User Guide	Opens this manual.	
	All Documents	Opens the Doc folder in the CME 2 installation folder (typically <i>c://Program Files/Copley Motion/CME 2/Doc</i>). This folder contains all of the related documents that were installed with CME 2.	
	Downloads Web Page	Opens default web browser with pages from Copley Controls' website.	
	Software Web Page		
	View Release Notes	Opens latest CME 2 release notes in a text viewer.	
	About	Displays CME 2 version information.	

2.7.3: Functional Diagram

The functional diagram, shown below, provides button-click access to most of the screens used to configure an amplifier. It also indicates the flow of control from input, across all active control loops, to motor/feedback. Only those control loop buttons that are appropriate to the amplifier and operational mode appear on the diagram.

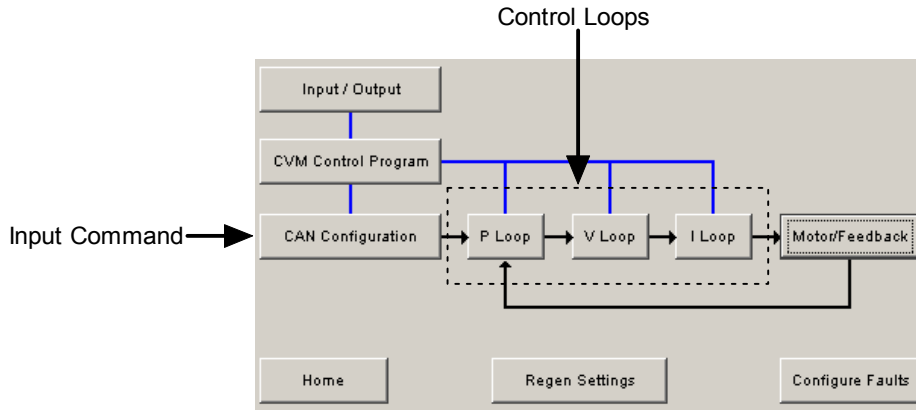

Name	Description	For More Information
Input/ Output	Opens Input/Output screen.	Digital Inputs and Outputs (p. 47)
CVM Control Program	Opens Copley Virtual Machine screen.	<i>Copley Indexer Program User's Guide.</i>
Input Command	Opens screen for configuring the input command. Button label varies depending on the selected control loop input.	Command Inputs (p. 57)
Control Loops	Each opens a control loop configuration screen.	Control Loops (p. 93)
Motor/ Feedback	Opens the Motor/Feedback screen.	Motor/Feedback (p. 37)
Home	Configure and test homing.	Homing (p. 127)
Regen Settings	Opens Regen Settings screen.	Regen Resistor Configuration (p. 187)
Configure Faults	Opens Fault Configuration screen.	Faults (p. 69)
Encoder Correction	(Stepper amplifier with encoder only.) Opens Encoder Correction screen.	Encoder Correction (p. 125)
Detent	(Stepper amplifier only). Opens stepper amplifier Advanced Tuning screen.	Detent Compensation Gain (p. 126)
Position Limits	(Stepper amplifier with encoder only.) Opens Position Limits screen.	Position Limits (Stepper Amplifier) (p. 123)

2.7.4: CAN or DeviceNet Information and Status Bar

CAN or DeviceNet Information

The *Main* screen displays the basic CAN or DeviceNet information. The example below shows CAN information:

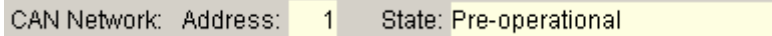

CAN Network: Address: 1 State: Pre-operational

The *Address* field shows the amplifier's present CAN or DeviceNet address. For more information, see [CAN Network Configuration \(p. 67\)](#) or the *Copley DeviceNet Programmer's Guide*. When the Position Loop Input is set to CAN, the *State* field shows the state of the amplifier's CANopen state machine (for more information, see Copley Control's *CANopen Programmer's Manual*).

Status Bar

The status bar describes the present commutation mode, motor type, and amplifier control status as shown below. It also includes a reminder that pressing the F12 function key while CME 2 is running disables the amplifier.



Sinusoidal Commutation Rotary Motor Amp Software Disabled F12 To Disable

CHAPTER

3: AMPLIFIER SETUP PROCEDURE

Perform the steps listed below, in the order presented, to set up and tune an amplifier/motor pair. Details follow in the chapter.

- 1** Prepare for setup (p. 25).
 - 2** Start CME 2 and enter Basic Setup parameters (p. 25).
 - 3** Enter Motor/Feedback/Brake Stop parameters (p. 26).
 - 4** Use Calculate to automatically set initial gains and limits (p. 26).
 - 5** Configure digital I/O (p. 26).
 - 6** Configure the command input (p. 26).
 - 7** Configure faults (p. 27).
 - 8** Configure an optional regen resistor (p. 27).
 - 9** Phase and jog the motor (p. 27).
 - 10** Tune the control loops (p. 27).
 - 11** Set gains and limits for stepper mode (stepper only) (p. 27).
 - 12** Configure Homing (p. 27).
 - 13** Test with load attached (p. 28).
-

NOTES: ServoTube motor setup steps are included within this procedure.

3.1: Warnings and Notes

NOTE: To immediately software disable the amplifier at any time while running CME 2, press function key **F12**. Also, the amplifier's enable input can be used to disable the amplifier.



DANGER

DANGER: Hazardous voltages.

Exercise caution when installing and adjusting.

Do not make connections to motor or drive with power applied.

Risk of unexpected or uncontrolled motion with CME 2 in CAN or DeviceNet mode.

CME 2 can be used while the amplifier is under CAN or DeviceNet control. However, some extreme changes made with CME 2 could cause unexpected or uncontrolled motion.

Failure to heed these warnings can cause equipment damage, injury, or death.



WARNING

Spinning motor with power off may damage amplifier.

Do not spin motors with power off. Voltages generated by a motor can damage an amplifier.

Failure to heed this warning can cause equipment damage.

3.2: Setup Procedure

1 Prepare for setup

- Understand this procedure's [Warnings and Notes \(p. 24\)](#).
- Verify that amplifier power is OFF.
- Verify wiring and connections.
- Make sure motor is securely fastened with no load connected.
- Apply power to the amplifier.
For Xenus amplifiers apply 24V only.
For Accelnet, or Stepnet: amplifiers apply AUX HV only.

2 Start CME 2 and enter Basic Setup parameters



- Double-click CME 2 icon on the Windows desktop to start CME 2.
- If necessary, [Connect to an Amplifier \(p. 17\)](#) from the list in the *Copley Neighborhood* tree.



- If the *Basic Setup* screen does not appear, click the **Basic Setup** button.

- Choose:

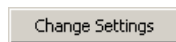

In most cases, click **Change Settings** to [Change Basic Setup Settings \(p. 30\)](#). Then proceed to Step 3 of this Setup Procedure, [Enter Motor/Feedback/Brake Stop parameters \(p. 26\)](#).

OR

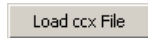

To load a .ccx file that was prepared for the amplifier/motor combination, see [Copy Amplifier Data \(p. 159\)](#). Then proceed to Step 13 of this Setup Procedure, [Test with load attached \(p. 28\)](#).

OR



To complete the setup for a ServoTube motor, click **ServoTube Setup** and see [ServoTube Setup \(p. 34\)](#).

Continued...

...Setup Procedure, continued:

3 Enter Motor/Feedback/Brake Stop parameters

-  Click **Motor/Feedback** to open the *Motor/Feedback* screen.
- To optionally load data from an existing motor data file, see [Load Motor/Feedback/Brake Settings from a File \(p. 39\)](#) and then skip to [Step 4, Use Calculate to automatically set initial gains and limits \(p. 23\)](#).

OR

- On the **Motor** tab, modify the appropriate [Rotary Motor Setup Parameters \(p. 40\)](#) or [Linear Motor Setup Parameters \(p.41\)](#).
- On the **Feedback** tab, as appropriate for each encoder or resolver, verify the parameters described in [Feedback Parameters, Rotary \(p. 42\)](#) or [Feedback Parameters, Linear \(p. 43\)](#).
- If using a brake, click the **Brake/Stop** tab to verify [Brake/Stop Parameters \(p. 44\)](#).

4 Use Calculate to automatically set initial gains and limits

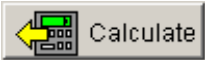
-  Click **Calculate** to have the software calculate and display initial loop gains and limits. See [The Calculate Function \(p. 46\)](#).
- Load the calculated values into amplifier RAM by clicking **OK**.

5 Configure digital I/O

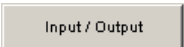
-  Click **Input/Output** on the *Main* screen to open the *Input/Output* screen. Verify the I/O settings described in [Digital Inputs and Outputs \(p. 47\)](#).
- On the *Input/Output* screen, click **Close**.

6 Configure the command input

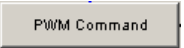
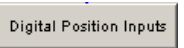
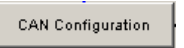
-  or  or  or  Click the appropriate button to configure the amplifier's command input. For more information see [Command Inputs \(p. 57\)](#).
NOTE: If the amplifier is to run CVM programs or in Camming mode see the relevant documents.
- After setting command input parameters, Click **Close**.

Continued...

...Setup Procedure, continued:

7 Configure faults

-  Click **Configure Faults** to open the *Fault Configuration* screen and set latching faults as needed. See [Faults \(p. 69\)](#).
- Click **OK** to close the *Fault Configuration* screen.

8 Configure an optional regen resistor

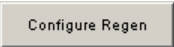
-  If the amplifier is equipped with a regen resistor, click **Regen Settings** to open the *Regen Settings* screen. See [Regen Resistor Configuration \(p. 187\)](#) for regen resistor parameters.
- Click **OK** to close the *Regen Settings* screen.

9 Phase and jog the motor

- Apply AC or HV power.
-  [Phase Motor with Auto Phase \(p. 76\)](#).
- To verify Auto Phase results, [Phase Motor Manually \(p. 86\)](#).
- [Run a move in jog mode \(p. 133\)](#) to verify that the amplifier can drive the motor.

10 Tune the control loops

- Starting with the Current Loop set up and tune all applicable [Control Loops \(p. 93\)](#). If you are setting up a linear motor, you can optionally [Tune All Loops with Auto Tune \(Linear Motors\) \(p. 115\)](#) instead.

11 Set gains and limits for stepper mode (stepper only)

- If tuning a stepper amplifier in stepper mode:
 - [Set Position Limits in Stepper Mode \(p. 123\)](#).
 - If using Encoder Correction, [Set Encoder Correction Gain \(p. 125\)](#).
 - [Tune Stepper Detent Gain \(p. 126\)](#).



12 Configure Homing

- [Configure Homing \(p. 127\)](#).

Continued...

...Setup Procedure, continued:

13 Test with load attached

-  On the CME 2 *Main* screen, click **Save to Flash**.
- Remove amplifier power.
- Attach load.
- Reconnect amplifier power.
- If necessary, re-tune velocity and position loops.
-  On the CME 2 *Main* screen, click **Save to Flash**.
-  On the CME 2 *Main* screen, click **Save to Disk** (for backup or duplication).
- The amplifier tuning procedure is complete.

NOTE: To copy the results of this setup to other amplifiers, see [Copy Amplifier Data \(p. 159\)](#).

CHAPTER

4: BASIC SETUP

This chapter describes the Basic Setup screen. Perform the basic steps outlined below to access and enter the Basic Setup options. Details follow in the chapter.

1  Click to open the *Basic Setup* screen.

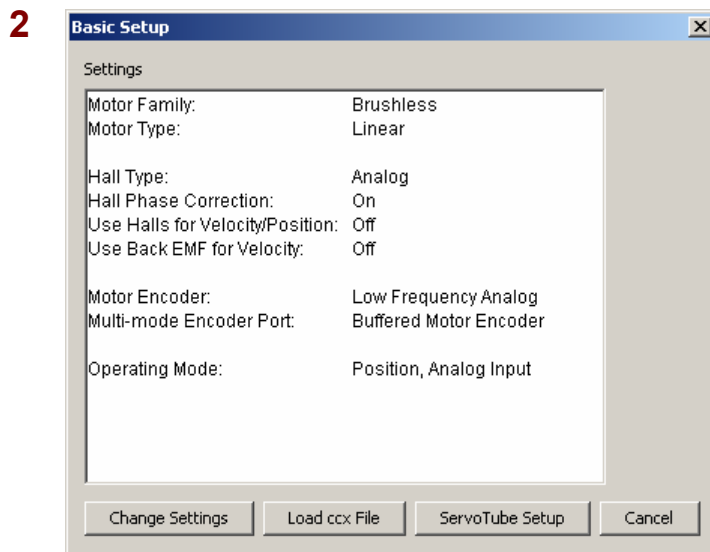

3 Review settings.

4 Choose:

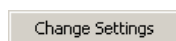

If necessary, click **Change Settings** to [Change Basic Setup Settings \(p. 30\)](#).

OR

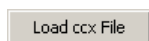

If you have a .ccx file that was prepared for the amplifier/motor combination, click **Load ccx File** and see [Copy Amplifier Data \(p. 159\)](#).

OR



To change Basic Setup settings for a ServoTube motor, click **ServoTube Setup** and see [ServoTube Setup \(p. 34\)](#).

OR

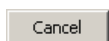

To accept the displayed settings, click **Cancel**.

4.1: Change Basic Setup Settings

- 1  On the Basic Setup screen, click **Change Settings** to start the Basic Setup wizard. Use the Back and Next buttons to navigate screens. Screen details vary depending on amplifier model and mode selection.

- 2 Set [Motor Options \(p. 31\)](#).

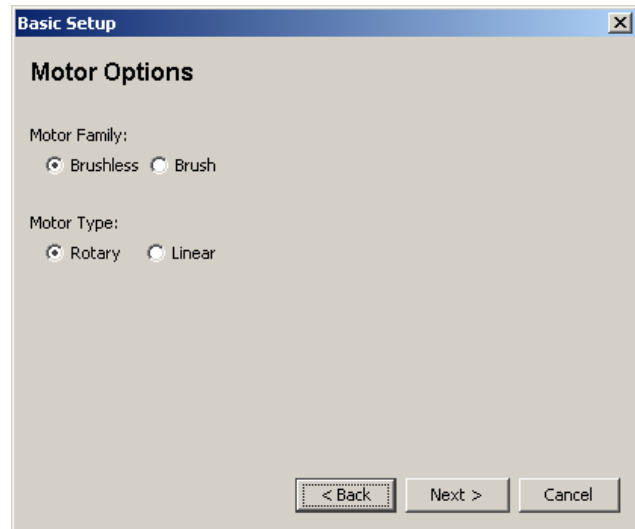

The screenshot shows the 'Basic Setup' dialog box with the 'Motor Options' tab selected. The 'Motor Family' section has radio buttons for 'Brushless' (selected) and 'Brush'. The 'Motor Type' section has radio buttons for 'Rotary' (selected) and 'Linear'. At the bottom right, there are three buttons: '< Back', 'Next >', and 'Cancel'.

- 3 Set [Feedback Options \(p. 32\)](#).

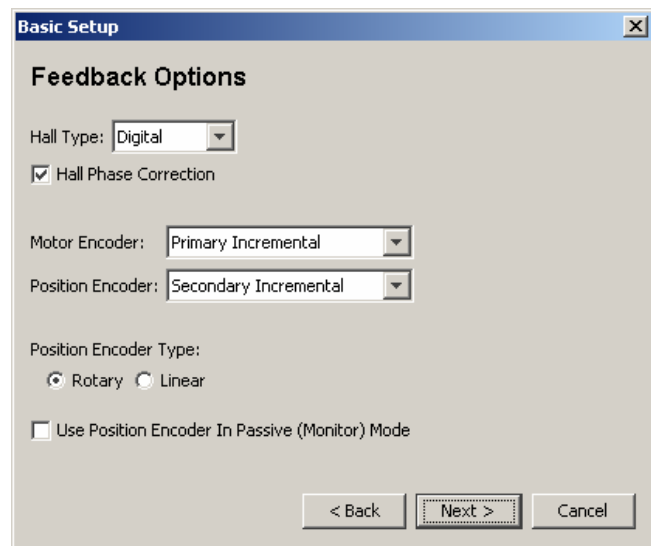

The screenshot shows the 'Basic Setup' dialog box with the 'Feedback Options' tab selected. The 'Hall Type' is set to 'Digital' in a dropdown menu. The 'Hall Phase Correction' checkbox is checked. The 'Motor Encoder' is set to 'Primary Incremental' and the 'Position Encoder' is set to 'Secondary Incremental' in dropdown menus. The 'Position Encoder Type' section has radio buttons for 'Rotary' (selected) and 'Linear'. The 'Use Position Encoder In Passive (Monitor) Mode' checkbox is unchecked. At the bottom right, there are three buttons: '< Back', 'Next >', and 'Cancel'.

Continued...

...Change Basic Setup Settings, continued:

4 Set Operating Mode Options (p. 33).

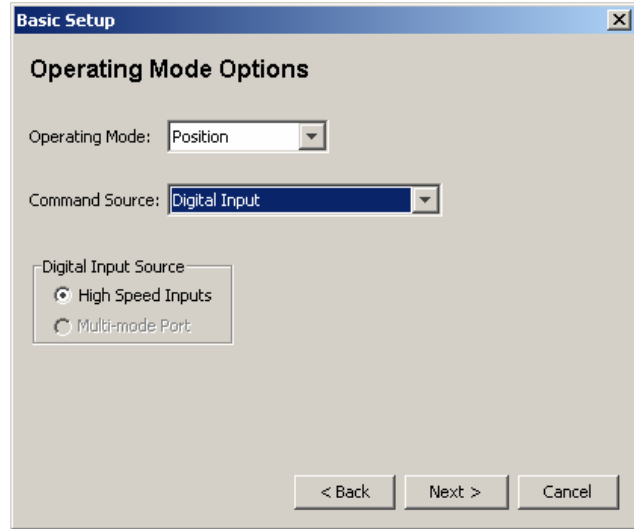

5 Set Miscellaneous Options (p. 33).

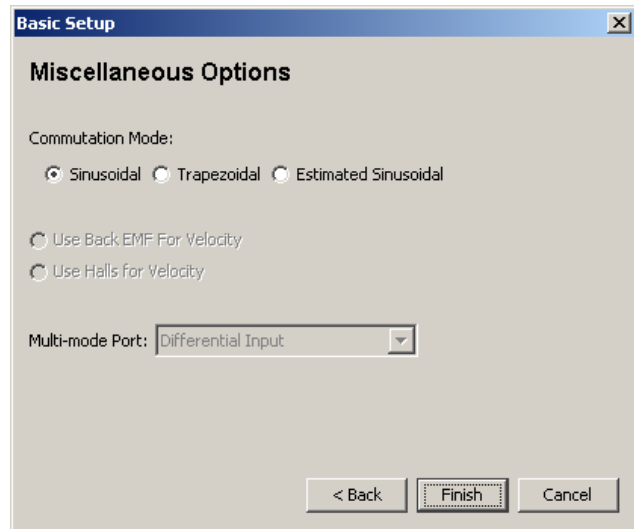

6 When satisfied with the settings, click **Finish** on the final screen.

4.2: Motor Options

View or change the settings described below. Options vary with amplifier model.

Setting	Description
Motor Family	Select motor family: Brushless, Brush, or Three Phase Stepper. (Three Phase Stepper configures the amplifier to operate as an open-loop stepper drive for three-phase stepper motors.)
Motor Type	Select motor type: Rotary or Linear.

4.3: Feedback Options

View or change the settings described below. Options vary with amplifier model.

Setting	Description
Hall Type	Select Hall type: None, Digital, or Analog (Analog is used with Copley Controls ServoTube motors).
Hall Phase Correction	If selected, will enable error checking between Hall switches and encoder based phase angle. See Faults (p. 69) .
Motor Encoder	Select type and source of motor feedback. <ul style="list-style-type: none"> • None: No motor encoder. • Primary Incremental: <i>Incremental encoder on primary feedback connector.</i> • Secondary Incremental: <i>Incremental encoder on multi-mode port.</i> • Analog: <i>Analog encoder on primary feedback connector.</i> • Low Frequency Analog: <i>Copley ServoTube motor on primary feedback connector.</i> • Resolver (Resolver version only): <i>Resolver on primary feedback connector.</i> Additional encoder types are supported by certain Copley Controls amplifier models. See the amplifier data sheet for more information.
Position Encoder	Select type and source of Position (load) feedback. <ul style="list-style-type: none"> • None: No position encoder • Primary Incremental: <i>Incremental encoder on primary feedback connector.</i> • Secondary Incremental: <i>Incremental encoder on multi-mode Port.</i> • Analog: <i>Analog encoder on primary feedback connector.</i>
Position Encoder Type	Select the type of Position (load) encoder: <ul style="list-style-type: none"> • Rotary. • Linear.
Use Position Encoder in Passive (Monitor) Mode	When this is checked, the position of the position encoder will be reported by the passive load position variable but it will not be used to control the position of the axis.
Stepper Amplifiers Only	
Motor Encoder	Select the encoder type: <ul style="list-style-type: none"> • None • Primary incremental
Run in Servo Mode	(With encoder only.) Amplifier operates as a true, closed loop, servo amplifier controlling a stepper motor.
Enable Encoder Correction	(With encoder only.) Amplifier runs as a stepper drive; encoder feedback is used to correct positional errors. See Encoder Correction (p. 125) .

For more information see [Motor/Feedback \(p. 37\)](#).

4.4: Operating Mode Options

View or change the settings described below. Options vary with amplifier model.

Setting	Description
Operating Mode	Choose the mode of operation: Current, Velocity, or Position. See Servo Operating Modes and Control Loops (p. 10) .
Command Source	Choose the command input source: <ul style="list-style-type: none"> • Analog Command: Analog voltage provides command input. See Command Inputs (p. 57). • PWM command (current and velocity mode only): Digital pulse-width modulated signal provides command input. See Command Inputs (p. 57). • Function Generator: Internal function generator provides command input. • Software Programmed: The amplifier is controlled by software commands from either the Copley Virtual Machine (CVM) or an external source. See <i>Copley Indexer Program User's Guide</i> or the <i>Copley ASCII Interface Programmer's Guide</i>. • Camming: Runs in Camming Mode. See <i>Copley Camming User Guide</i>. • Digital Input: Command input is provided via the chosen Input Source (below). See Digital Position Input Settings (p. 62). • CAN: Command input is provided over the CANopen network. See the <i>CANopen Programmer's Guide</i>.
Input Source	Choose the input source for PWM or Digital input commands: <ul style="list-style-type: none"> • Single-ended Inputs: Command input is provided via two of the amplifier's programmable digital inputs. • Multi-mode Port: Command input is provided via differential inputs on the amplifier's multi-mode port. • Differential Inputs: Command is provided via differential inputs. • High Speed Inputs: Command is provided via two of the amplifier's high speed inputs.

4.5: Miscellaneous Options

View or change the settings described below. Options vary with amplifier model.

Setting	Description
Commutation	Commutation method: Sinusoidal, Trapezoidal, or Estimated Sinusoidal.
Use back EMF for Velocity	If selected, will use the motor's measured back EMF to determine motor velocity. Recommended only for medium- to high-speed. Accuracy depends on the accuracy of the programmed Back EMF value, and may be affected by factors such as cable resistance.
Use Halls for Velocity and Position	If selected, will use transitions of the Hall switches to determine motor velocity and position. Recommended only for medium- to high-speed applications (may run roughly at low speeds).
Multi-mode Port	Selects the mode for the amplifier's multi-mode port: <ul style="list-style-type: none"> • Buffered Motor Encoder. The multi-mode port functions as a buffered digital encoder output based on the digital encoder input. • Emulated Motor Encoder. The multi-mode port functions as an emulated digital encoder output based on the motor analog encoder or motor resolver. • Emulated Position Encoder. The multi-mode port functions as an emulated digital encoder output based on the position analog encoder. • Differential Input. The multi-mode port functions as a differential command input.

4.6: ServoTube Setup

The ServoTube Setup tool sets up the amplifier for use with the chosen ServoTube motor. After the user selects the motor series and model, CME 2 performs the following actions:

- Sets motor-specific values for all feedback options in the Basic Setup screen.
- Provides motor-specific values for all settings in the Motor/Feedback screens.
- Performs the Calculate function to set initial gains and limits.
- Sets the appropriate programmable digital input as Motor Over Temperature.
- Phases the motor.
- Saves all values to flash.
- Opens the Control Panel so the user can [Run a move in jog mode \(p. 133\)](#).

Set Up a ServoTube Motor

1  On the Basic Setup screen, Click **ServoTube Setup** to start the Basic Setup wizard. Use the Back and Next to move from screen to screen as needed.

2 Choose the appropriate **Series** and **Model**. Optionally choose to **Invert Motor Direction**. Optionally choose the **Additional Encoder Option** (available with certain motor series) and choose the appropriate resolution for the optional encoder (1 um or 5 um).

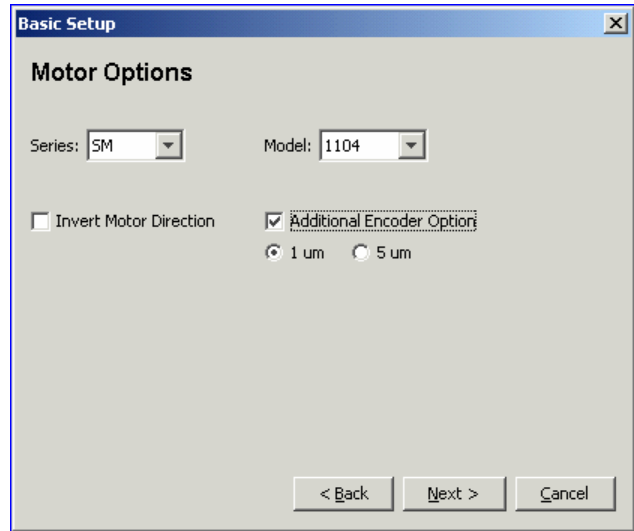

3 Set [Operating Mode Options \(p. 33\)](#).

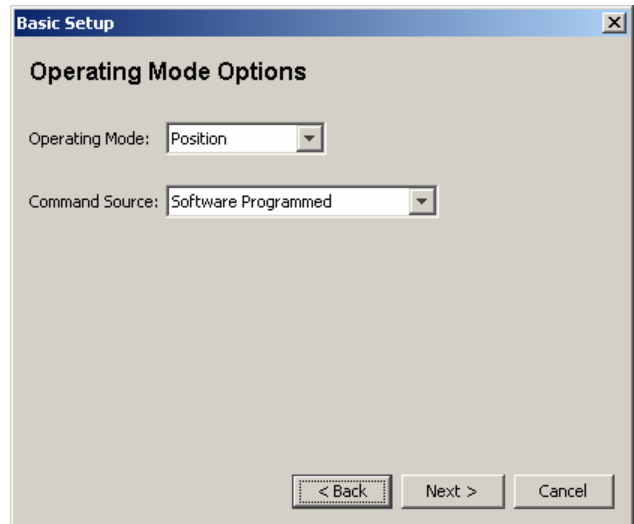

Continued...

...Set Up a ServoTube Motor, continued:

4 Set [Miscellaneous Options \(p. 33\)](#).

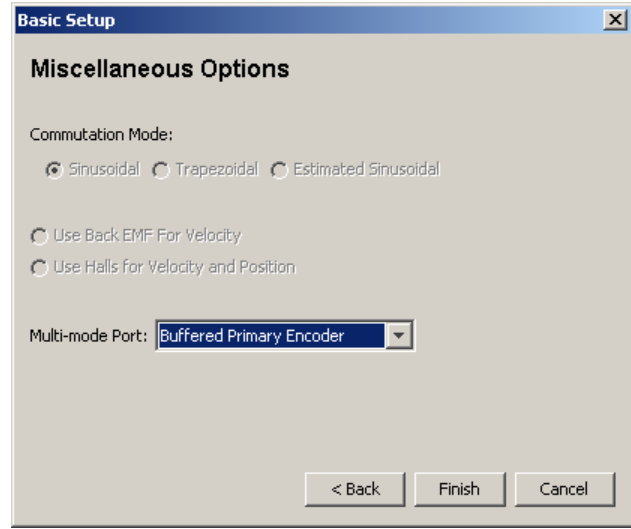

5 When satisfied with the settings, click **Finish**.
The control panel opens.

6 To test basic move capabilities, [Run a move in jog mode \(p. 133\)](#).

7 [Test with load attached \(p. 28\)](#).

CHAPTER

5: MOTOR/FEEDBACK

This chapter describes motor, feedback, and brake parameters, and the Calculate function. Access these features as described below. Details follow in the chapter.

1

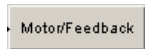

Click **Motor/Feedback** to open the *Motor/Feedback* screen.

2



[Load Motor/Feedback/Brake Settings from a File \(p. 39\)](#).

OR

2

Enter settings manually:

▪



Click the **Motor** tab to view or change [Rotary Motor Setup Parameters \(p. 40\)](#) or [Linear Motor Setup Parameters \(p. 41\)](#).

▪

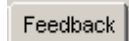

Click the **Feedback** tab to view or change [Feedback Parameters, Rotary \(p.42\)](#) or [Feedback Parameters, Linear \(p. 43\)](#). Read the [Feedback Notes \(p. 44\)](#) for important related information.

▪

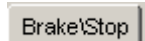

Click the **Brake/Stop** tab to view or change [Brake/Stop Parameters \(p. 45\)](#). Read the [Brake/Stop Notes \(p. 45\)](#) for important related information.

▪

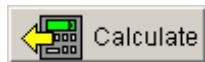

Use [The Calculate Function \(p. 46\)](#) to calculate initial gains and limits.

▪



On the Main screen, click **Save to Flash** to avoid losing the changes.

5.1: Motor/Feedback Screen Overview

A typical Motor/Feedback screen is shown below. Parameters vary with amplifier model.

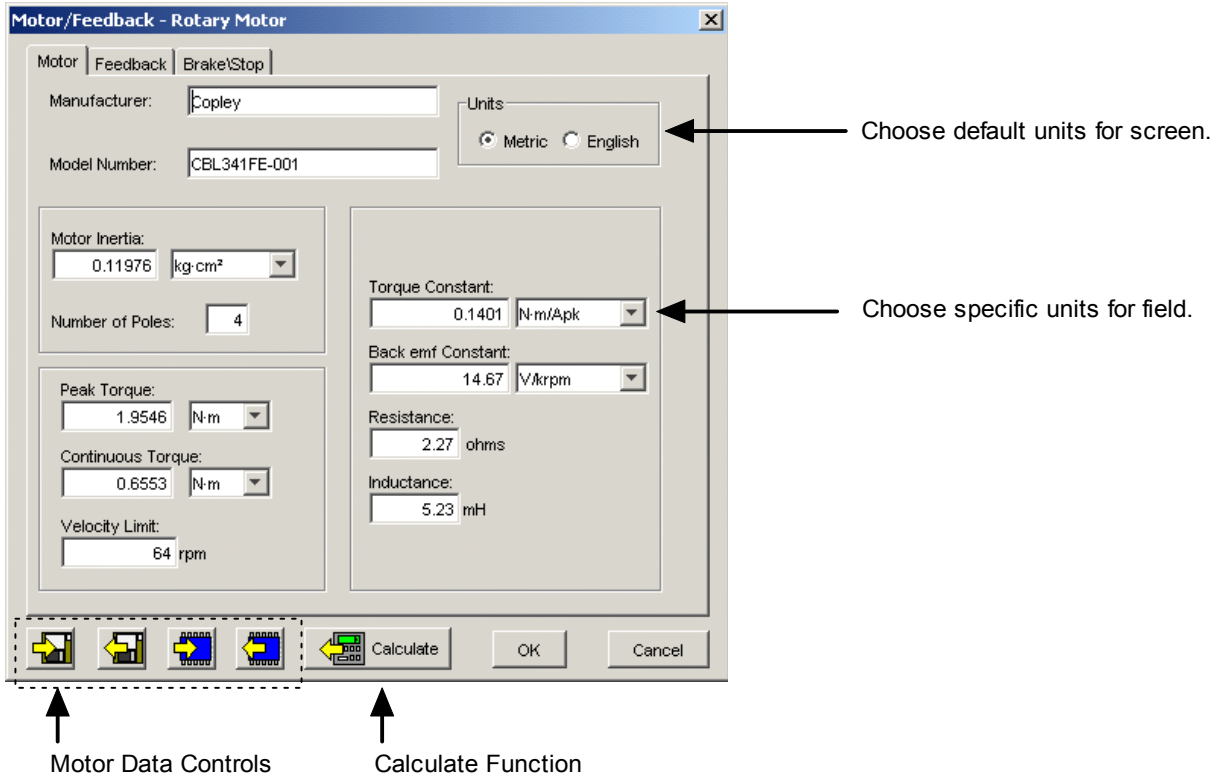



The Calculate function is described in [The Calculate Function \(p. 46\)](#).

Data on the Motor/Feedback screen can be saved to and restored from disk files using the controls described below.

Icon	Name	Description
	Save motor data to disk	Saves motor/feedback/brake settings from PC to a disk file with . <i>cm</i> name extension.
	Restore motor data from disk	Restores contents of a . <i>cm</i> file from disk to PC.
	Save motor data to flash	Saves motor/feedback/brake settings from PC to amplifier permanent flash memory.
	Restore motor data from flash	Restores motor/feedback/brake settings from flash memory to the PC.

For more information see [Data, Firmware, and Logs \(p. 149\)](#).

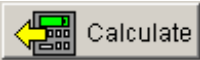
5.2: Load Motor/Feedback/Brake Settings from a File

- 1 If needed, download the motor data file from the Copley Controls website:
 - In an internet browser, navigate to <http://www.copleycontrols.com/Motion/Downloads/motorData.html>
 - Click on the appropriate motor name.
 - When prompted, save the file to the *MotorData* folder in the CME 2 installation folder.
 - (The default installation folder is C:\Program Files\Copley Motion\CME 2\MotorData.)
 - Extract the contents of the zip file to the same location.
 - The folder should now contain the new motor data file (with a *.ccm* filename extension).
 - If desired, delete the *.zip* file to save disk space.
 - 2 Load the motor data into the amplifier:
 -  Click **Motor/Feedback** to open the *Motor/Feedback* screen.
 - On the *Motor/Feedback* screen, click **Restore Motor Data from Disk**. When prompted, navigate to the folder containing the file, then click on the file name, and then click **Open**.
 -  Calculate initial gains and limits with [The Calculate Function \(p. 46\)](#).
 -  On the Main screen, click **Save to Flash** to avoid losing the changes.
-

5.3: Rotary Motor Setup Parameters

View or change the settings described below. Options vary with amplifier model. Metric units are shown here.

Setting	Description
Manufacturer	Motor manufacturer's name. Saved for reference in the motor data file.
Model Number	Motor model number. Saved for reference in the motor data file.
Units	Selects whether the parameters entered in this screen are in Metric or English units.
Motor Inertia	The rotor inertia of the motor. Used for calculating initial velocity loop tuning values. Range: 0.00001 to 4,294 kg cm ² . Default: 0.00001 kg-cm ² .
Number of Poles	(Brushless only.) The number of magnetic poles in the motor. Required for correct commutation of the motor. If the number of poles is not known, Verify the motor's pole count (p. 91) . Range: 2 to 200. Default: 4.
Peak Torque	The peak torque that the motor can produce. Peak Torque divided by torque constant = motor's peak current limit. Range: 0.001 to 2,100 Nm. Default: 0.0001 Nm.
Continuous Torque	The continuous torque that the motor can produce. Used with the torque constant to calculate continuous current. Range: 0.001 to 1,000 Nm. Default: 0.0001 Nm.
Velocity Limit	Maximum speed of the motor. Used to calculate the velocity and acceleration limits for the velocity loop. Range dependent on encoder resolution.
Torque Constant	Relates the motor's input current to torque produced. Sometimes abbreviated as Kt. Range: 0.001 to 1,000 Nm/Apk. Default: 0.001 Nm/Apk.
Back emf Constant	Relates the motor's input voltage to speed. Sometimes abbreviated as Ke. Used for calculating the maximum velocity for a given amplifier bus voltage. Range: 0.01 to 21,000,000 V/Krpm. Default: 0.01 V/Krpm.
Resistance	Motor resistance line-to-line. Used for calculating the initial current loop tuning values. Range: 0.01 to 327 Ω. Default: 0.01 Ω.
Inductance	Motor inductance line-to-line. Used for calculating the initial current loop tuning values. Range: see the hardware documentation.
Stepper Amplifiers Only	
Rated Torque	Motor's rated operating torque. Min: .001. Max: 1000.
Rated Current	Motor's rated continuous current. Min: 0.001. Max: 1000.
Basic Step Angle	Fundamental stepper motor step, in degrees. Min: 0.225. Max: 22.5. Default 1.8.
Microsteps/Rev	Number of microsteps per revolution of the motor. Min: 4. Max: 100,000,000. Default 4000.
Full Steps/Rev	This read-only value can be used after entering Basic Step Angle to cross-check against motor data sheet.

5.4: Linear Motor Setup Parameters

View or change the settings described below. Options vary with amplifier model. Metric units are shown here.

Setting	Description
Manufacturer	Motor maker's name. Saved in the motor data file. Choose from list or enter manually.
Model Number	Motor model number. Saved in the motor data file. Choose from list or enter manually.
Units	Selects whether the parameters entered in this screen are in Metric or English units.
Mass	The mass of the motor. Used for calculating initial velocity loop tuning values. Range: .0001 Kg to 100,000 Kg. Default: .0001 Kg.
Peak Force	The peak force that the motor can produce. Peak Force divided by Force Constant = motor's peak current limit. Range: 0.00001 to 2,000 N. Default: 0.00001 N.
Continuous Force	The continuous force that the motor can produce. Used with the force constant to calculate continuous current. Range: 0.00001 to 1,000 N. Default: 0.00001 N.
Velocity Limit	Maximum speed of the motor. Used to calculate the velocity and acceleration limits for the velocity loop. Range dependent on encoder resolution.
Force Constant	Relates the motor's input current to force produced. Sometimes abbreviated as Kf. Range: 0.00001 to 2,000 N/Amp. Default: 0.00001 N/Amp.
Back emf Constant	Relates the motor's input voltage to speed. Sometimes abbreviated as Ke. Used for calculating maximum velocity for a given amplifier voltage. Range: 0.01 to 1,000 V/M/Sec. Default: 0.01 V/M/Sec.
Resistance	Motor resistance line to line. Used for calculating the initial current loop tuning values. Range: 0.01 to 327 Ω . Default: 0.01 Ω .
Inductance	Motor inductance line to line. Used for calculating the initial current loop tuning values. Range: see the hardware documentation.
Magnetic Pole Pair Length	The length of a pair of magnets which equals the distance moved in one electrical cycle of the motor.
Stepper Amplifiers Only	
Rated Force	Motor's rated operating force. Min .001 N. Max 1000 N.
Rated Current	Motor's rated continuous current. Min: 0.01 A. Max 1000 A.
Full Step	Fundamental stepper motor step distance. Min: 0.0001mm. Max: 5000 mm.
Microsteps/ Full Step	Number of microsteps per full step. Min: 1. Max: 100,000,000.

5.5: Feedback Parameters, Rotary

As appropriate for each encoder or resolver, enter the parameters described here. Options vary with amplifier model.

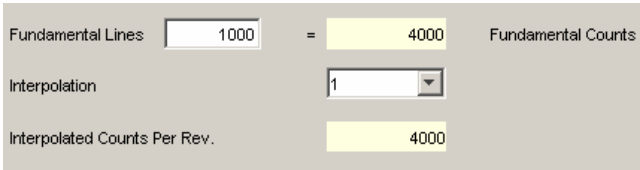
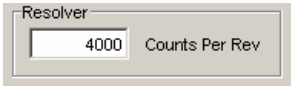
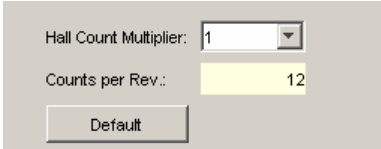
Feedback Type	Parameters/Actions
Incremental	<p>In the <i>Motor Encoder lines</i> or <i>Position Encoder lines</i> field, enter the number of encoder lines (see encoder or motor data sheet). As indicated by the counts field, the number of encoder counts per revolution is equal to 4 x the number of lines.</p> 
Analog	<p>In Fundamental Lines, enter the number of fundamental encoder lines (see encoder or motor data sheet). As indicated by the <i>Fundamental Counts</i> field, the number of fundamental encoder counts per revolution is equal to 4 x the number of Fundamental Lines.</p> <p>Optionally modify the encoder resolution by changing the Interpolation value. The interpolated resolution (Interpolated Counts Per Rev) is the product of Fundamental Counts value and the Interpolation value.</p> 
Resolver	<p>Optionally modify the feedback resolution by changing the value in Counts Per Rev. Default: 16384.</p> 
Halls	<p>With amplifier set to Use Halls for Velocity/Position, optionally increase the counts per rev ratio by incrementing the Halls Count Multiplier.</p> 

If two feedback devices are installed, verify that the values of Motor Turns to Position Turns correctly represent the ratio of motor encoder turns to position encoder turns. The details of the following screen may vary depending on the types of feedback devices present.

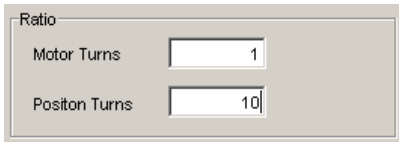

5.6: Feedback Parameters, Linear

As appropriate for each encoder installed, enter the parameters described below. Options vary with amplifier model.

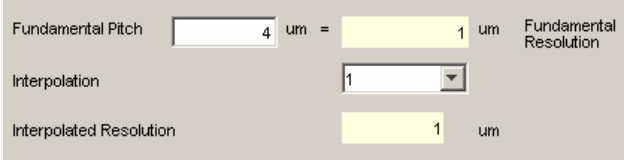
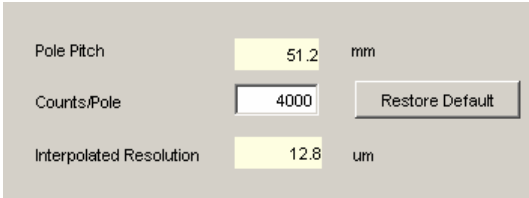
Feedback Type	Parameters/Actions
Incremental	Choose units and then enter the Encoder Resolution (see encoder or motor data sheet).  Encoder Resolution: <input type="text" value="10"/> <input type="radio"/> mm <input checked="" type="radio"/> um <input type="radio"/> nm
Analog	Enter the Fundamental Pitch (distance between encoder lines; see encoder or motor data sheet). As indicated by the <i>Fundamental Resolution</i> field, Fundamental Pitch divided by four gives Fundamental Resolution. The interpolated resolution is the dividend of Fundamental Resolution value/Interpolation value. Optionally modify the Interpolated Resolution by changing the Interpolation value.  Fundamental Pitch <input type="text" value="4"/> um = <input type="text" value="1"/> um Fundamental Resolution Interpolation <input type="text" value="1"/> Interpolated Resolution <input type="text" value="1"/> um
Low Frequency Analog	(Normally used with ServoTube) Pole Pitch is the distance between poles in a poll pair, as entered in the <i>Magnetic Pole Pair Length</i> field on the Motor tab. The interpolated resolution is the dividend of Pole Pitch/Counts per pole value, expressed in micrometers. Optionally modify the resolution by changing the Counts/Pole value. Click Restore Default to restore default Counts/Pole.  Pole Pitch <input type="text" value="51.2"/> mm Counts/Pole <input type="text" value="4000"/> <input type="button" value="Restore Default"/> Interpolated Resolution <input type="text" value="12.8"/> um

5.7: Feedback Notes

5.7.1: Encoder and Resolver Support

Some Copley Controls amplifiers are offered in multiple versions to support different types of encoder or resolver feedback. Some encoder versions support digital quadrature encoders, some support analog sin/cos encoders, and others support both. Encoder versions normally require Hall switches for the commutation of brushless motors. The resolver versions support standard, single speed, transmit-type resolvers.

5.7.2: Dual Feedback Amplifiers

Some Copley Controls amplifiers can receive position feedback from sensors on the motor, the load, or both, through the Primary Feedback channel, a Secondary Feedback channel (multi-mode port) or both. (Some amplifiers can also operate in certain modes without encoders or resolvers.)

When the amplifier is configured with a multi-mode port (see [Feedback Options, p. 32](#)) the multi-mode port can:

- Provide a buffered digital encoder output based on the digital encoder input.
- Provide an emulated digital encoder output based on the analog encoder or resolver input.
- Provide a second digital encoder input to be used in the dual encoder position mode. In this mode, an encoder attached to the load provides position loop feedback, and the motor encoder or resolver provides velocity loop feedback.

A dual-feedback setup is shown below. The amplifier receives feedback from an incremental motor encoder through the Primary feedback channel. Position (load) encoder feedback comes through the multi-mode port. The ratio of motor turns to position encoder turns is 1 to 10.

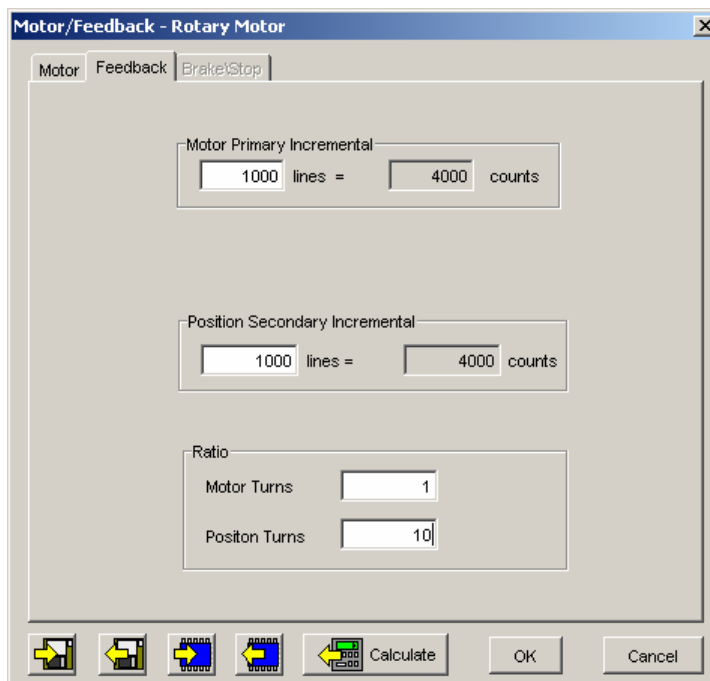

5.8: Brake/Stop Parameters

Enter the following parameters as appropriate.

Parameter	Description
Brake/Stop Delay Time	Range of accepted values: 0 to 10,000 mSec
Brake Activation Velocity	Range of accepted values: 0 to 183,105 rpm (mm/s for linear motor)
PWM Delay Brake/Stop Response Time	Range of accepted values: 0 to 10,000 mSec

5.9: Brake/Stop Notes

Many control systems employ a brake to hold the axis when the amplifier is disabled. On brake-equipped systems, disabling the amplifier by a hardware or software command starts the following sequence of events.

- The motor begins to decelerate (at *Abort Deceleration* rate in position mode or *Fast Stop Ramp* rate in velocity mode). At the same time, the *Brake/Stop Delay Time* count begins. This allows the amplifier to slow the motor before applying the brake.
- When the motor slows to *Brake/Stop Activation Velocity* OR the *Brake/Stop Delay Time* expires, the brake output activates and *PWM Delay Brake/Stop Response Time* count begins.
- When response time has passed, the amplifier's output stages are disabled. This delay ensures the brake has time to lock in before disabling the power section.

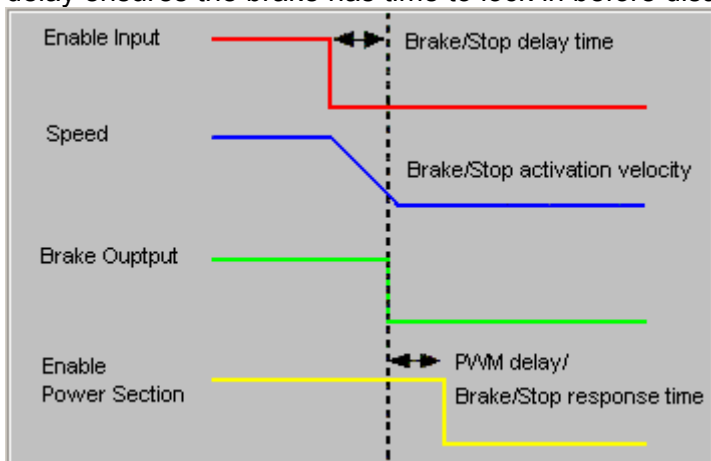

This sequence is not available in the current mode of operation. Instead, in current mode, the amplifier output turns off and the brake output activates immediately when the disable command is received.

5.10: The Calculate Function

The *Calculate* function uses programmed motor and encoder values to calculate initial gains and limits. These can be modified to fine-tune the amplifier. Follow the steps below:

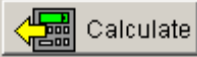
- 1  **Calculate** Click **Calculate** to calculate and display the settings.

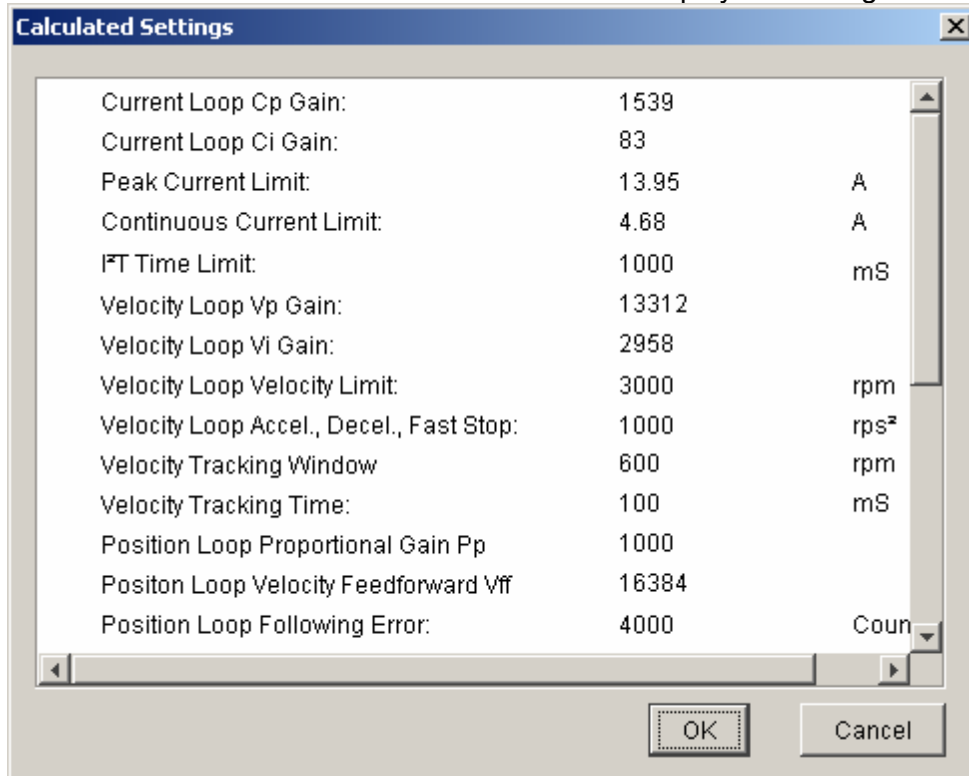

- 2 Verify the peak current limit, continuous current limit, and velocity loop velocity limit. If one or more of these values seems inappropriate, click **Cancel** and check: Peak Torque (or Force), Continuous Torque (or Force), Velocity Limit, and Torque (or Force) Constant. Correct them if needed. See [Rotary Motor Setup Parameters \(p. 40\)](#) or [Linear Motor Setup Parameters \(p. 41\)](#).

If the Motor/Feedback values were correct but the peak current limit, continuous current limit, or velocity loop velocity limit values are not optimal for the application, change these limits during the tuning process.

- 3 Load the values into amplifier RAM by clicking **OK**.
NOTE: When loading motor data from a file, if the motor wiring configuration in the motor file does not match the configuration currently stored in the amplifier, CME prompts for verification on which configuration to use. Select the file configuration by clicking **Yes**. The configuration will be tested as part of [Motor Phasing \(p. 75\)](#).

- 4  On the Main screen, click **Save to Flash** to avoid losing the changes.

CHAPTER

6: DIGITAL INPUTS AND OUTPUTS

This chapter shows how to configure the amplifier's digital inputs and outputs. Perform the steps outlined below. Details follow in the chapter.

1

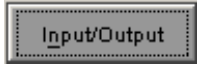

Click **Input/Output** to open the *Input/Output* screen.

2

As needed, set [Digital Inputs \(p. 48\)](#).

3

As needed, set [Digital Outputs \(p. 50\)](#).

4

Click **Close** to close screen and save changes to amplifier RAM.

5



On the Main screen, click **Save to Flash** to avoid losing the changes.

6.1: Digital Inputs

6.1.1: Digital Inputs Screen Overview

A typical Input/Output screen is shown below. (Features vary with amplifier model and configuration.)

Red light: inhibited motion or active input, depending on input function.

Grey light: motion not inhibited.

No light: not configured.

Lo/Hi: Indicates state of input.

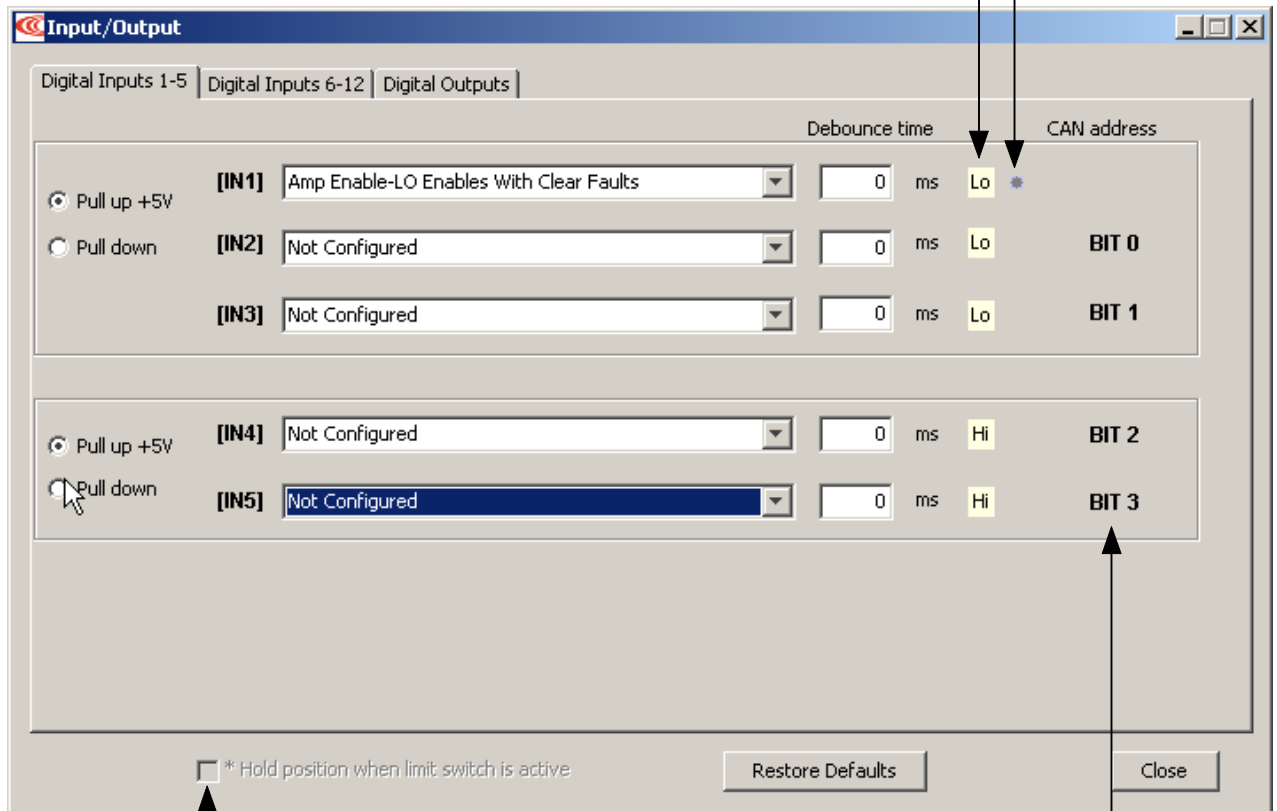

Hold position setting

Indicates input is used as a CAN address bit.

Parameter	Description
Pull up +5 V	Pulls up the group of inputs up to internal +5 V.
Pull down	Pulls the group of inputs down to internal signal ground.
Debounce Time	Specifies how long an input must remain stable at a new state before the amplifier recognizes the state. Increase to prevent multiple triggering caused by switch bounce upon switch closures. Range: 0 to 10,000 mSec. Debounce does not affect inputs that have been configured as PWM, Pulse and Direction, or Quadrature control inputs.
IN1-IN12	Select the function for the input. See Digital Input Functions (p. 49) for input function descriptions.
*Hold position when limit switch is active	Available in position mode when one or more inputs are configured as a limit switch (NEG Limit-HI Inhibits, NEG Limit-LO Inhibits, POS Limit-HI Inhibits, or POS Limit-LO Inhibits). The *Hold position option prevents any motion while a limit switch is active. This option uses the Abort Deceleration rate to stop the motor as described in Trajectory Limits (p. 113) . CAUTION: If the amplifier is switched back to current or velocity mode with this option selected, the limit switches will no longer function.
Restore Defaults restores all inputs and outputs to factory defaults. Close button closes the screen.	

6.1.2: Digital Input Functions

The programmable digital input functions are described below.

Input Function	Description
AMP Enable-LO Enables with clear faults	A low input will enable the amplifier. Any transition will clear latched faults and outputs.
AMP Enable-HI Enables with clear faults	A high input will enable the amplifier. Any transition will clear latched faults and outputs.
AMP Enable-LO Enables with reset	A low input will enable the amplifier. A low to high transition will reset the amplifier.
AMP Enable-HI Enables with reset	A high input will enable the amplifier. A high to low transition will reset the amplifier.
AMP Enable-LO Enables	A low input will enable the amplifier.
AMP Enable-HI Enables	A high input will enable the amplifier.
Not Configured	No function assigned to the input.
NEG Limit-HI Inhibits*	A high input will inhibit motion in negative direction.
NEG Limit-LO Inhibits*	A low input will inhibit motion in negative direction.
POS Limit-HI Inhibits*	A high input will inhibit motion in positive direction.
POS Limit-LO Inhibits*	A low input will inhibit motion in positive direction.
Reset on LO-HI Transition	A low to high transition of the input will reset the amplifier.
Reset on HI-LO Transition	A high to low transition of the input will reset the amplifier.
Motor Temp HI Disables	A high input will generate a Motor Over Temperature fault.
Motor Temp LO Disables	A low input will generate a Motor Over Temperature fault.
Home Switch Active HI	A high input indicates the home switch is activated.
Home Switch Active LO	A low input indicates the home switch is activated.
Motion Abort Active HI	A high input causes the amplifier to stop motion, using the Abort Deceleration rate described in Trajectory Limits (p. 113) . The amplifier remains enabled.
Motion Abort Active LO	A low input causes the amplifier to stop motion, using the Abort Deceleration rate described in Trajectory Limits (p. 113) . The amplifier remains enabled.
Hi Res Analog Divide Active HI	A high input causes the firmware to divide the level of the analog input signal by 8.
Hi Res Analog Divide Active LO	A low input causes the firmware to divide the level of the analog input signal by 8.
High Speed Position Capture on LO-HI Transition	Position will be captured on the low to high transition of the input.
High Speed Position Capture on HI-LO Transition	Position will be captured on the high to low transition of the input.
PWM Sync Input	PWM synchronization input. See Synchronizing PWM Switching Frequency (p. 56) . (For high-speed inputs only.)

6.1.3: Standard Input Function Assignments

Enable Input: On most Copley Controls amplifiers, IN1 is dedicated to the enable function. Accelus uses IN2 for the enable function.

Other inputs can be programmed as additional enables. If there is more than one input programmed as an enable then all the inputs must be in the enabled state before the amplifier PWM output stage will be enabled.

Motor Over Temperature: On most Copley Controls panel amplifiers, IN5 is located on the motor feedback connector and is intended to be used for Motor Over Temperature.

Other: Other inputs may have predefined functions depending on mode of operation.

6.2: Digital Outputs

6.2.1: Screen Overview

A typical *Digital Outputs* screen is shown below. Options vary with amplifier.

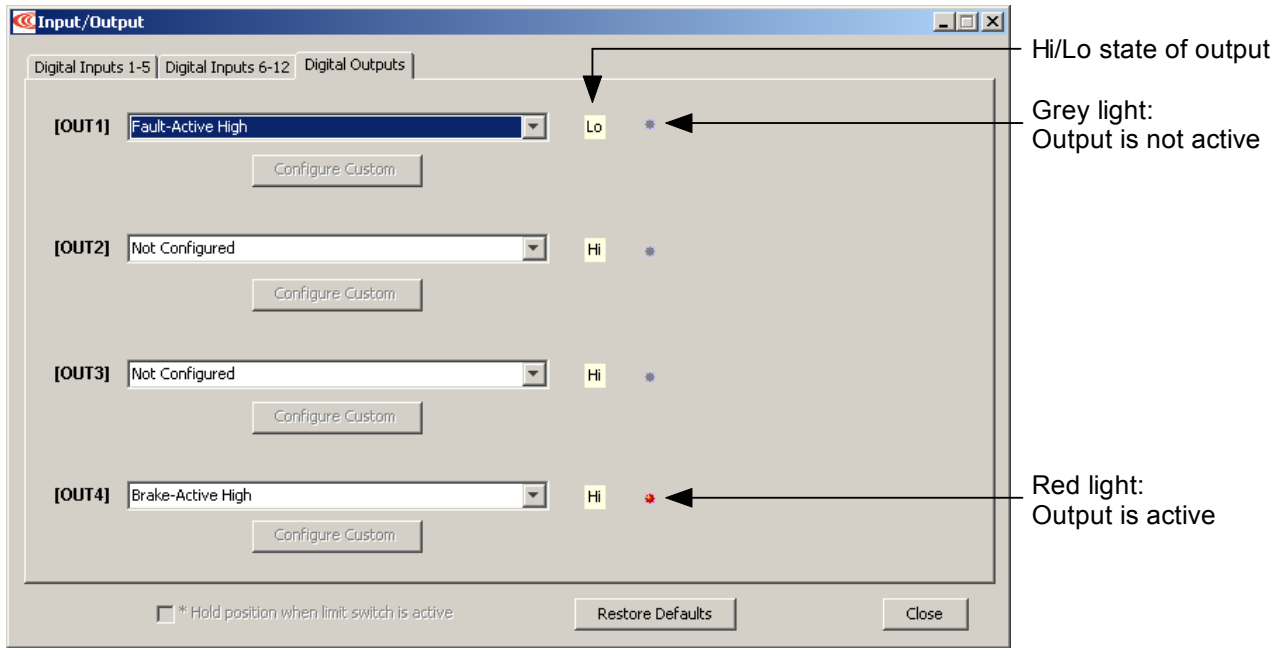

Parameter	Description
Configure Custom	Opens screen to display custom digital output settings. Available only when function is set to Custom.
Restore Defaults	Restores all inputs and outputs to factory defaults.
Close	Closes screen and saves changes to amplifier RAM.

6.2.2: Standard Output Functions

The standard output functions are described below. Custom output functions follow.

Output Function	Description
Not Configured	No function. Output remains high.
Fault Active High	Output goes high when one or more faults are detected. See Faults (p. 69) .
Fault-Active Low	Output goes low when one or more faults are detected.
Brake-Active High	Output goes high to activate the brake. See Brake/Stop Parameters (p. 45) .
Brake-Active Low	Output goes low to activate the brake. See Brake/Stop Parameters (p. 45) .
PWM Sync Output (OUT1 only)	The PWM synchronization output. See Synchronizing PWM Switching Frequency (p. 56) .
Custom Event	See Custom Digital Output Settings: Custom Event (p. 51) .
Custom Trajectory Status	See Custom Digital Output Settings: Custom Trajectory Status (p. 54) .
Custom Position Triggered Output	See Custom Output Settings: Position Triggered Output (p. 55) .
Program Control Active High	Output state controlled by CVM or external program.
Program Control Active Low	Output state controlled by CVM or external program

6.2.3: Custom Digital Output Settings: Custom Event

Any of the amplifier’s digital outputs can be programmed to respond to a combination of events including faults, warnings, and status indications. The output goes active when one or more of the selected events take place.

Configure a Custom Event output

1

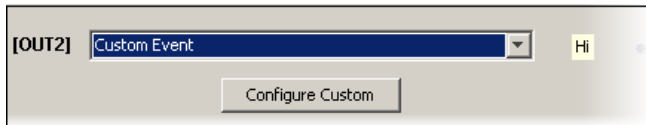

Choose **Custom Event** for an output and then click **Configure Custom** to open the *Event Configuration* screen.

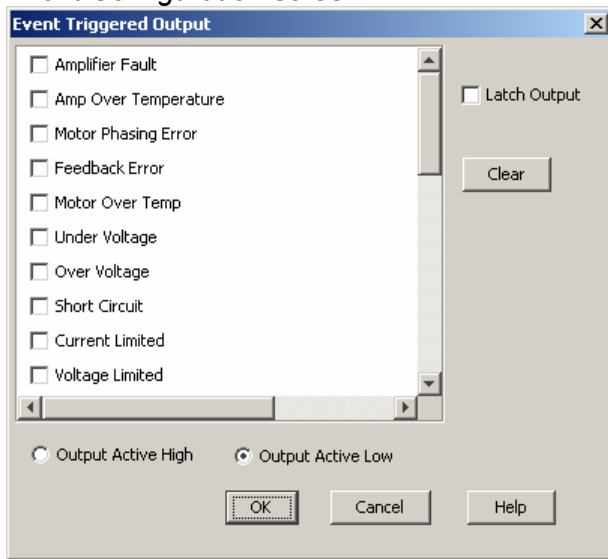

2

Select one or more [Custom Event Functions \(p. 52\)](#). Multiple functions are OR’ed together, so any event activates the output.

3

Choose Output Active High to have the output go high when active or Output Active Low to have the output go low when active.

4

To latch the output, set the **Latch Output** option. The **Clear** button clears all check marks.



DANGER

Latching an output does not eliminate the risk of unexpected motion with non-latched faults.

Associating a fault with a latched, custom-configured output does not latch the fault itself. After the cause of a non-latched fault is corrected, the amplifier re-enables without operator intervention. In this case, motion may re-start unexpectedly.

Failure to heed this warning can cause equipment damage, injury, or death.

5

Click **OK** to save changes to amplifier RAM and close the screen.

Custom Event Functions

Select any combination of events to configure a custom event output:

Event	Description
Amplifier Fault	A latched fault is active.
Amp Over Temperature	For descriptions of these fault events, see Fault Configuration Parameters (p. 70) .
Motor Phasing Error	
Feedback Error	
Motor Over Temperature	
Under Voltage	
Over Voltage	
Short Circuit	
Current Limited	The current output is being limited by the I ² T algorithm or a latched current fault has occurred. See Limits (p. 100) .
Voltage Limited	Current loop is commanding the full bus voltage in an attempt to control current. Commonly occurs when the motor is running as fast as the available bus voltage will allow.
Positive Limit Switch	Axis has contacted positive limit switch.
Negative Limit Switch	Axis has contacted negative limit switch.
Amp Disabled by Hardware	Amplifier enable input(s) is not active.
Amp Disabled by Software	Amplifier is disabled by a software command.
Attempting to Stop Motor	The amplifier, while in velocity or position mode, has been disabled. In velocity mode, amplifier is using the Fast Stop Ramp described in Velocity Loop Limits (p. 104) . In position mode, the amplifier is using the Abort Deceleration rate described in Trajectory Limits (p. 113) . The output remains active until the amplifier is re-enabled.
Motor Brake Active	Motor brake activated. See Brake/Stop Notes (p. 45) .
PWM Outputs Disabled	The amplifier's PWM outputs are disabled.
Positive Software Limit	Actual position has exceeded the positive software limit setting. See Homing (p. 127) .
Negative Software Limit	Actual position has exceeded the negative software limit setting. See Homing (p. 127) .
Following Error	Following error has reached programmed fault limit. See Following Error Fault Details (p. 73) .
Following Warning	Following error has reached programmed warning limit. See Following Error Fault Details (p. 73) .
Position has Wrapped	The position counters have exceeded the maximum range of $-2^{31} - 2^{31} - 1$ and have wrapped. Normal amplifier operation is not affected.
Velocity Limited	The velocity command (from analog input, PWM input, or position loop) has exceeded the velocity limit. See Velocity Loop Limits (p. 104) .
Acceleration Limited	In velocity mode, motor has reached an acceleration or deceleration limit that was set as described in Velocity Loop Limits (p. 104) .
Pos Outside of Tracking Window	The following error has exceeded the programmed value. See Tracking Window Details (p. 74) .
Home Switch Active	Axis has contacted the home limit switch.
In Motion	The motor is moving, or it has not yet settled after a move. The amplifier is settled when it comes within the position tracking window and stays there for the tracking time at the end of a move. Once this bit is set, it remains set until a new move is started.
Vel Outside of Tracking Window	Difference between target and actual velocity has exceeded the window. See Tracking Window Details (p. 74) .
Phase not Initialized	Amplifier is using Phase Initialization function and phase is not initialized.
Command Input Fault	See Fault Configuration Parameters (p. 70) .

Non-Latched vs. Latched Custom Event Digital Outputs

Like an amplifier fault, a custom-configured output can be non-latched or latched.

If a non-latched, custom-configured digital output goes active, it goes inactive as soon as the last of the selected events is cleared.

If a latched output goes active, it remains active until at least one of the following actions has been taken:

Power-cycle the amplifier

OR Cycle (disable and then enable) an enable input that is configured as *Enables with Clear Faults* or *Enables with Reset*.

OR  Access the CME 2 Control Panel and press **Clear Faults** or **Reset**.

Custom Event Output Fault Handling vs. Overall Fault Handling

A fault on an output programmed for Custom Event is separate from a fault on the amplifier. For instance, suppose:

- OUT3 has a *Custom Event* configuration. Only the *Under Voltage* fault condition is selected, and the output is latched.
- *Under Voltage* is not latched on the *Configure Faults* screen.

An under voltage condition occurs, and the amplifier goes into fault condition, output stages are disabled, and faults are reported. At the same time, OUT3 goes active.

The under voltage condition is corrected, and:

- The amplifier fault is cleared. Output stages are enabled.
- OUT3 remains active.

6.2.4: Custom Digital Output Settings: Custom Trajectory Status

Any of the amplifier’s digital outputs can be programmed to respond to a combination of amplifier trajectory status conditions. The output goes active when one or more of the conditions is met.

Configure a Custom Trajectory Status output

1

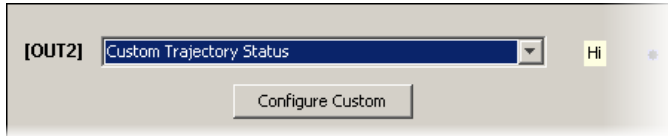

Choose **Custom Trajectory Status** for an output and then click **Configure Custom** to open the *Trajectory Status Configuration* screen.

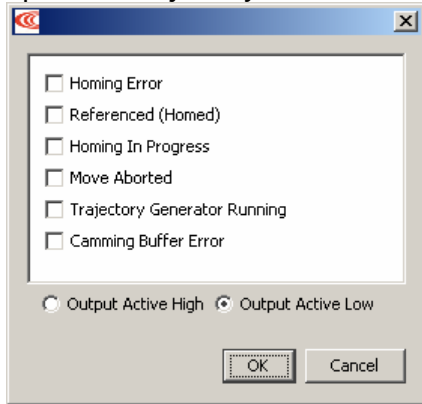

2

Select one or more trajectory status conditions described below. Multiple functions are OR’ed together, so any status match activates the output.

Trajectory Status Functions	
Status	Description
Homing Error	Activate output if an error occurred in the last homing attempt.
Referenced (Homed)	Activate output if the most recent homing attempt was successful.
Homing in Progress	Activate output when a homing move is in progress.
Move Aborted	Activate output if move is aborted.
Trajectory Generator Running	Activate output while trajectory generator is generating a move.
Camming Buffer Error	A camming buffer error has occurred.

3

Choose Output Active High to have the output go high when active or Output Active Low to have the output go low when active.

4

Click **OK** to save changes to amplifier RAM and close the screen.

6.2.5: Custom Output Settings: Position Triggered Output

Any of the amplifier’s digital outputs can be programmed to respond in certain ways to the position of the controlled axis. The output goes active when the axis position meets the specified criteria.

Configure a Position Triggered output

1

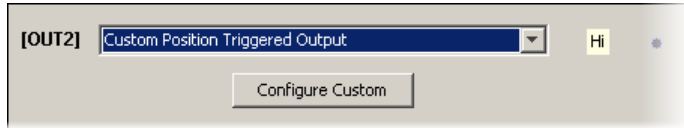

Choose **Custom Position Triggered Output** for an output and then click **Configure Custom** to open the *In Position Configuration* screen.

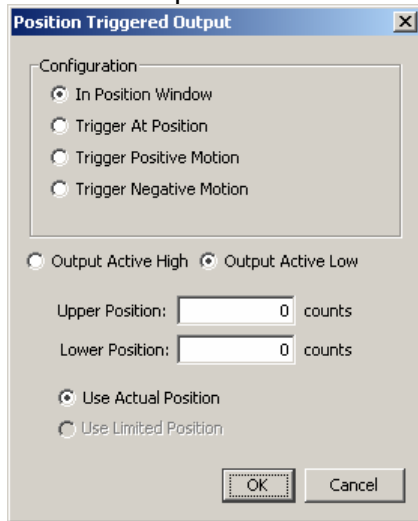

2

Select one of the configurations described below and enter appropriate values for the parameters.

Configuration	Description and Parameters
In Position Window	Activates the output while the axis is in the window between the programmed Upper and Lower positions.
Trigger at Position	Activates the output for the programmed Time when the axis travels through the programmed Position .
Trigger Positive Motion	Activates the output for the programmed Time when the axis travels in the positive direction through the programmed Position .
Trigger Negative Motion	Activates the output for the programmed Time when the axis travels in the negative direction through the programmed Position .

3

Choose Output Active High to have the output go high when active or Output Active Low to have the output go low when active.

4

In stepper mode with no encoder, choose **Use Limited Position**. Otherwise choose **Use Actual Position**.

5

Click **OK** to save changes to amplifier RAM and close the *Custom Output Configuration* screen.

6.3: Synchronizing PWM Switching Frequency

In some situations, such as when sampling small analog signals, it is desirable to synchronize the PWM switching frequency among multiple amplifiers. In these cases, one amplifier serves as a master for one or more slave amplifiers. The PWM sync output of the master sends a signal that is received as a PWM sync input by each slave.

CHAPTER

7: COMMAND INPUTS

This chapter shows how to configure the amplifier's command inputs. Perform the basic steps outlined below. Details follow in the chapter.

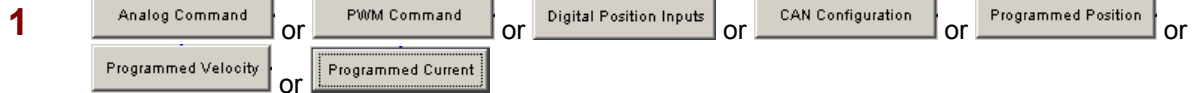

Click to open the loop command input settings screen.

2 Change/verify command input parameters as described in the following sections:

- [Analog Command Settings \(p. 58\)](#)
- [PWM Input Settings \(p. 60\)](#)
- [Digital Position Input Settings \(p. 62\)](#) or
- [CAN Network Configuration \(p. 67\)](#)
- [Software Programmed Input Settings \(p. 65\)](#)
- *Copley Camming User Guide*

3 Click **Close** to close screen and save changes to amplifier RAM.

7.1: Analog Command Settings

View or change the settings described below.

Parameter	Description
Scaling	<p>Current mode: output current produced by +10 Vdc of input. Range: 0 to 10,000,000 A. Default: <i>Peak Current</i> value.</p> <p>Velocity mode: output velocity produced by +10 Vdc of input. Range: 0 to 100,000 rpm (mm/sec). Default: <i>Maximum Velocity</i> value.</p> <p>Position mode: position change (counts or mm) produced by +10 Vdc of input. Range: 0 to 1,000,000,000 counts. Default: 1 Revolution of a rotary motor or 1 pole pair distance for a linear motor. For more information, see Scaling (p. 58).</p>
Dead Band	Sets dead band. Range: -10,000 to 10,000 mV. Default: 0. For more information, see Dead Band (p. 59) .
Invert Command	Inverts polarity of amplifier output with respect to input signal.
Offset	(Current and Velocity modes only.) Used to offset input voltage error in an open loop system. Not recommended for use when the amplifier is part of a closed loop system. Range: -10,000 to 10,000 mV. Default: 0. For more information, see Offset (p. 59) .
Analog Input Filter	Programmable input filter. Disabled by default. See Low-Pass and Bi-Quad Filters (p.169) .
For more information, see Analog Command Notes (p. 58) .	

7.1.1: Analog Command Notes

The amplifier can be driven by an analog voltage signal through the analog command input. The amplifier converts the signal to a current, velocity, or position command as appropriate for current, velocity, or position mode operation, respectively.

The analog input signal is conditioned by the scaling, dead band, and offset settings.

Scaling

The magnitude of the command generated by an input signal is proportional to the input signal voltage. Scaling controls the input-to-command ratio, allowing the use of an optimal command range for any given input voltage signal range.

For example, in current mode, with default scaling, +10 Vdc of input generates a command equal to the amplifier's peak current output; +5 Vdc equals half of that.

Scaling could also be useful if, for example, the signal source generates a signal range between 0 and +10 Vdc, but the command range only requires +7.5 Vdc of input. In this case, scaling allows the amplifier to equate +7.5 Vdc with the amplifier's peak current (in current mode) or maximum velocity (in velocity mode), increasing the resolution of control.

Dead Band

To protect against unintended response to low-level line noise or interference, the amplifier can be programmed with a “dead band” to condition the response to the input signal voltage. The amplifier treats anything within the dead band ranges as zero, and subtracts the dead band value from all other values. For instance, with a dead band of 100 mV, the amplifier ignores signals between -100 mV and $+100$ mV, and treats 101 mV as 1 mV, 200 mV as 100 mV, and so on.

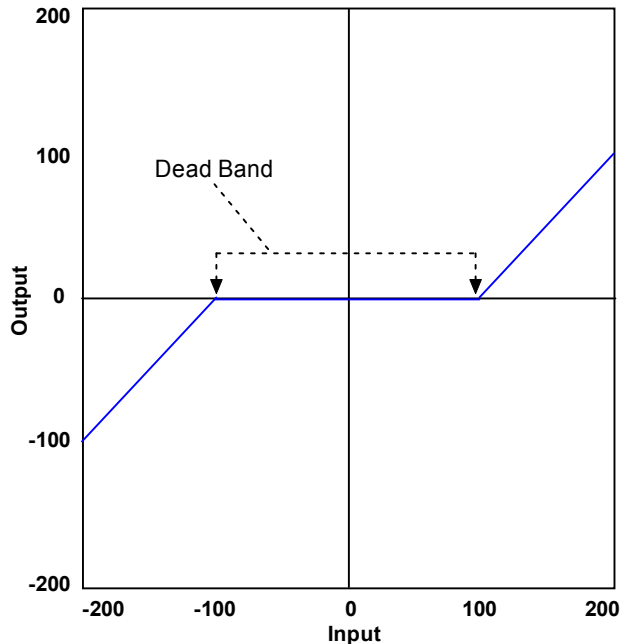

Offset

To remove the effects of voltage offsets between the controller and the amplifier in open loop systems, CME 2 provides an *Offset* parameter and a *Measure* function. The *Measure* function takes 10 readings of the analog input voltage over a period of approximately 200 ms, averages the readings, and then displays the results. The *Offset* parameter allows the user to enter a corrective offset to be applied to the input voltage.

The offset can also set up the amplifier for bi-directional operation from a uni-polar input voltage. An example of this would be a 0 to +10 Vdc velocity command that had to control 1000 rpm CCW to 1000 rpm CW. Scale would be set to 2000 rpm for a +10 Vdc input and Offset set to -5V. After this, a 0 Vdc input command would be interpreted as -5 Vdc, which would produce 1000 rpm CCW rotation. A +10 Vdc command would be interpreted as +5 Vdc and produce 1000 rpm CW rotation.

Monitoring the Analog Command Voltage

The analog input voltage can be monitored in the Control Panel and in the Scope Tool. The voltage displayed in both cases is after both offset and deadband have been applied.

Analog Command in Position Mode

The Analog Position command operates as a relative motion command. When the amplifier is enabled the voltage on the analog input is read. Then any change in the command voltage will move the axis a relative distance, equal to the change in voltage, from its position when enabled.

To use the analog position command as an absolute position command, the amplifier should be homed every time it is enabled. The Homing sequence may be initiated by CAN, ASCII serial, DeviceNet, or CVM Indexer program commands.

7.2: PWM Input Settings

View or change the settings described below.

Parameter	Description
Scaling	<p>Current mode: output current at 100% duty cycle. Range: 0 to 10,000,000 A. Default: <i>Peak Current</i> value.</p> <p>Velocity mode: output velocity at 100% duty cycle. Range: 0 to 100,000 rpm (mm/sec). Default: <i>Maximum Velocity</i> value.</p>
PWM Input Type	One wire 50% or two wire 100% with direction.
Options	<p>Invert PWM input: Inverts the PWM logic.</p> <p>Allow 100% output: Overrides the 100% command safety measure. See Failsafe Protection from 0 or 100% Duty Cycle Commands (p. 61).</p> <p>Invert Sign Input: In 100% duty cycle mode, inverts the polarity of the directional input.</p>
For more information, see PWM Input Notes (p. 60) .	

7.2.1: PWM Input Notes

Two Formats

The amplifier can accept a pulse width modulated signal (PWM) signal to provide a current command in current mode and a velocity command in velocity mode. The PWM input can be programmed for two formats: 50% duty cycle (one-wire) and 100% duty cycle (two-wire).

50% Duty Cycle Format (One-Wire)

The input takes a PWM waveform of fixed frequency and variable duty cycle. As shown below, a 50% duty cycle produces zero output from the amplifier. Increasing the duty cycle toward 100% commands a positive output, and decreasing the duty cycle toward zero commands a negative output.

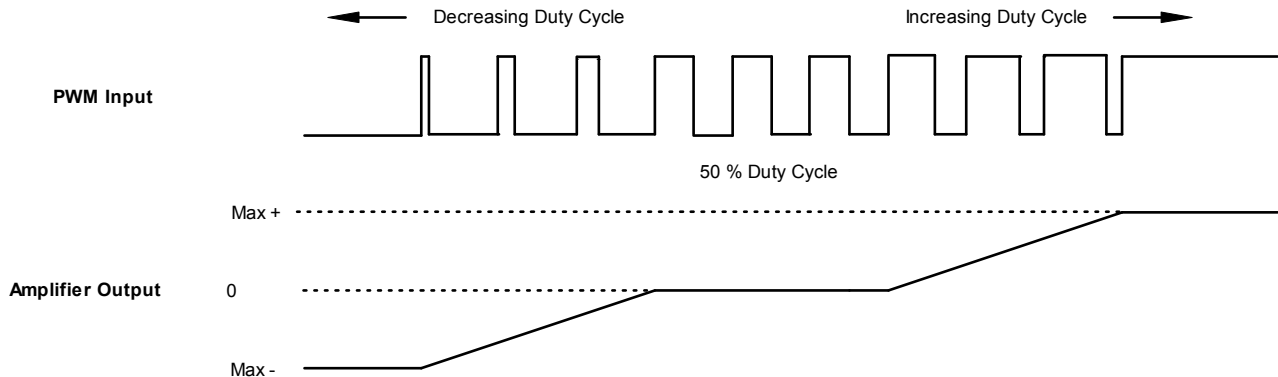

The command can be inverted so that increased duty cycle commands negative output and vice versa.

100% Duty Cycle Format (Two-Wire)

One input takes a PWM waveform of fixed frequency and variable duty cycle, and the other input takes a DC level that controls the polarity of the output. A 0% duty cycle creates a zero command, and a 100% duty cycle creates a maximum command level. The command can be inverted so that increasing the duty cycle decreases the output and vice versa.

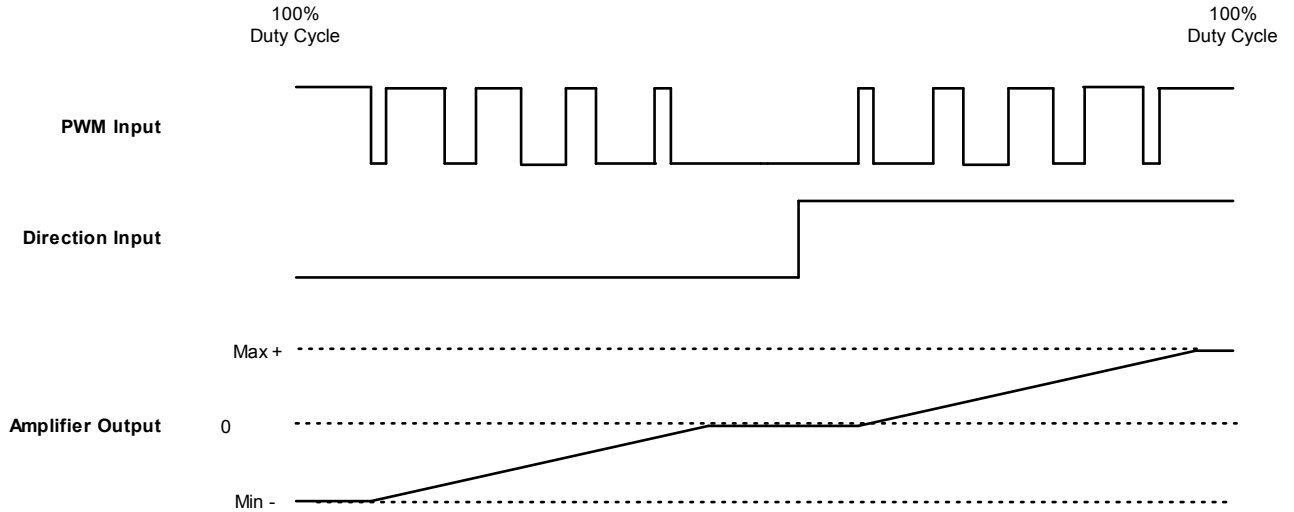

Failsafe Protection from 0 or 100% Duty Cycle Commands

In both formats, the amplifier can be programmed to interpret 0 or 100% duty cycle as a zero command, providing a measure of safety in case of controller failure or cable break.

7.3: Digital Position Input Settings

View or change the settings described below.

Parameter	Description
Control Input	<p>Pulse and Direction: One input takes a series of pulses as motion step commands, and another input takes a high or low signal as a direction command.</p> <p>Pulse Up / Pulse Down: One input takes each pulse as a positive step command, and another takes each pulse as a negative step command.</p> <p>Quadrature: A/B quadrature commands from a master encoder (via two inputs) provide velocity and direction commands.</p>
Increment position on	<p>Rising Edge: Increment position on the rising edge of the input pulse.</p> <p>Falling Edge: Increment position on the falling edge of the input pulse.</p>
Stepping Resolution	<p>Input Pulses: Number of Input Pulses required to produce output counts. Range: 1 to 32,767. Default: 1.</p> <p>Output Counts: Number of Output Counts per given number of input pulses. Range: 1 to 32,767. Default: 1.</p>
Invert Command	When selected, inverts commanded direction.
For more information, see Digital Position Input Notes (p. 62) .	

7.3.1: Digital Position Input Notes

Three Formats

In position mode, the amplifier can accept position commands using one of these signal formats: pulse and direction, count up/count down, and quadrature.

In all three formats, the amplifier can be configured to invert the command.

Pulse Smoothing

In digital position mode, the amplifier’s trajectory generator can be used to create trapezoidal profiles, with programmed acceleration, deceleration and velocity, from a simple pulse train or burst of pulses

To bypass the trajectory generator while in digital or analog position modes, set the maximum acceleration to zero. The only limits in effect will now be the velocity loop velocity limit and the current limits. (Note that leaving the maximum acceleration set to zero will prevent other position modes from operating correctly.)

Pulse and Direction Format

In pulse and direction format, one input takes a series of pulses as motion step commands, and another input takes a high or low signal as a direction command, as shown below.

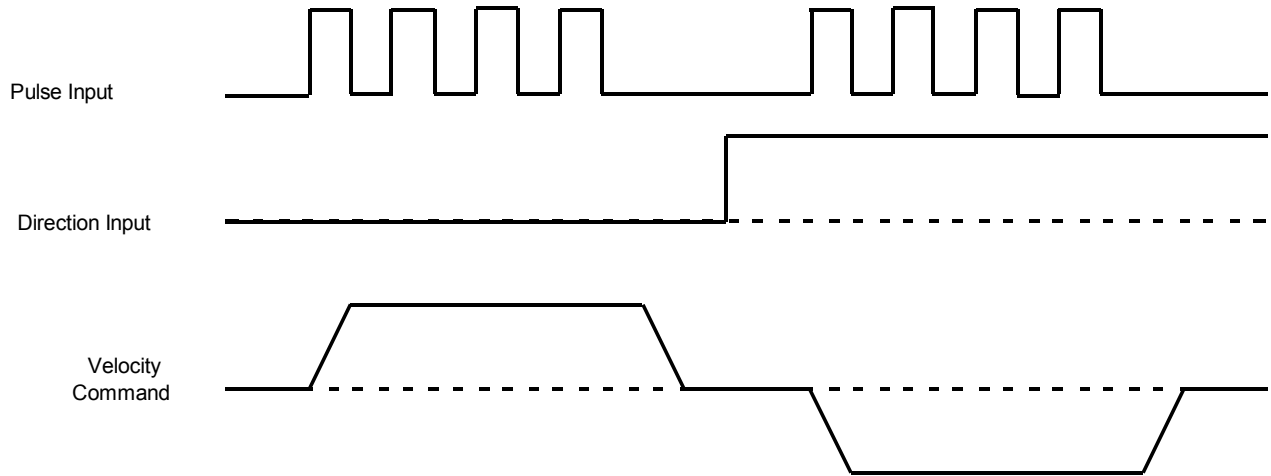

The amplifier can be set to increment position on the rising or falling edge of the signal. Stepping resolution can be programmed for electronic gearing.

Count Up/Count Down Format

In the count up/count down format, one input takes each pulse as a positive step command, and another takes each pulse as a negative step command, as shown below.

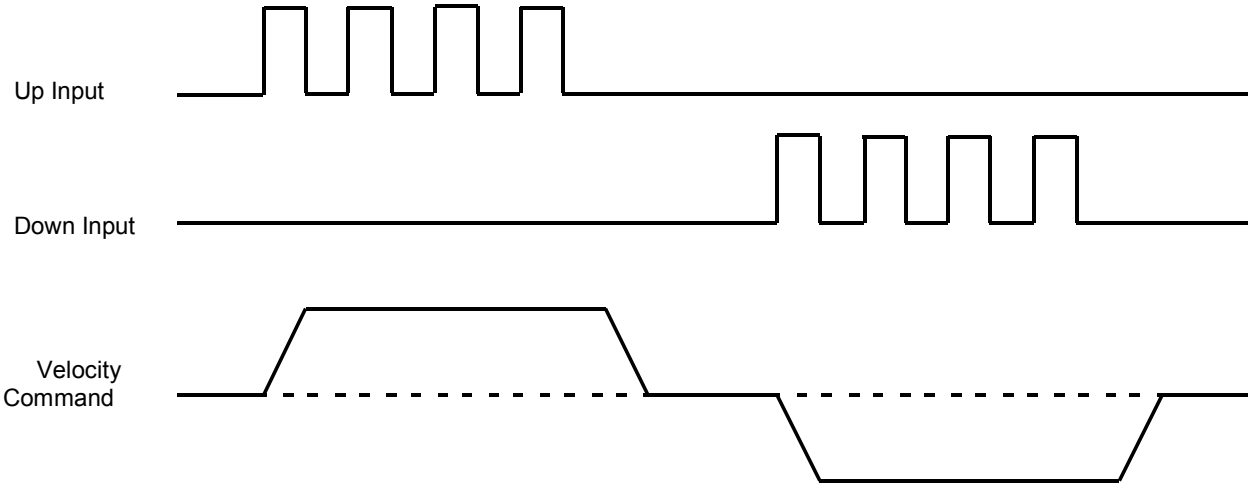

The amplifier can be set to increment position on the rising or falling edge of the signal. Stepping resolution can be programmed for electronic gearing.

Quadrature Format

In quadrature format, A/B quadrature commands from a master encoder provide velocity and direction commands, as shown below.

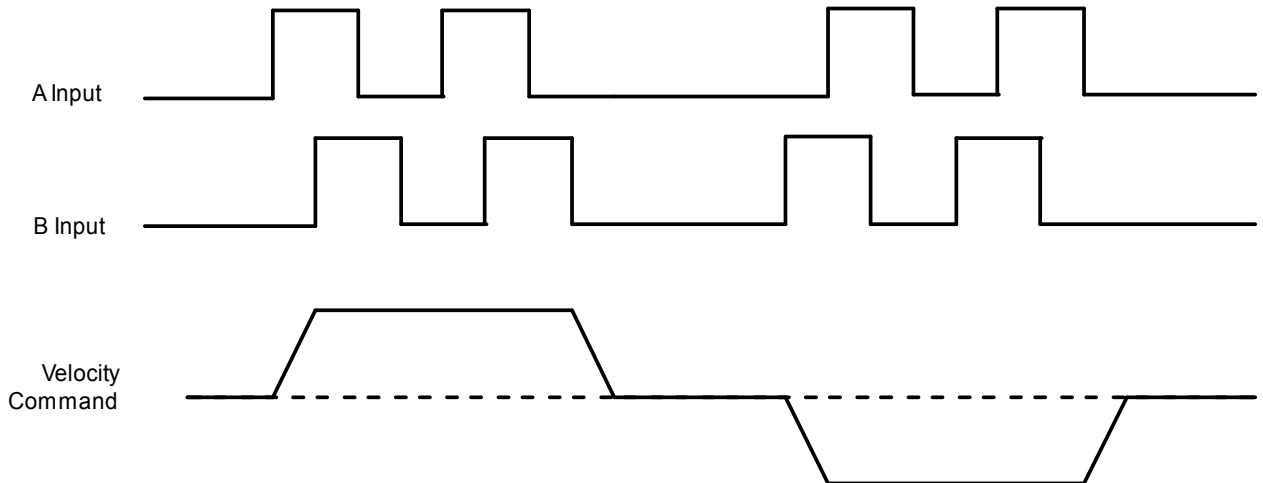

The ratio can be programmed for electronic gearing.

7.4: Software Programmed Input Settings

These settings can be saved to flash to allow default conditions to be set and used when the amplifier is powered up or reset.



DANGER

Potential for unexpected movement.

If Programmed Velocity or Programmed Current are set to values other than 0, the motor will move after power-up or reset if the amplifier is hardware enabled.

Failure to heed this warning can cause equipment damage, injury, or death.

7.4.1: Programmed Position

View or change the settings described below.

Setting	Description
Move	Relative or Absolute.
Type	Trap or S-Curve.
Distance	Move distance.

7.4.2: Programmed Velocity

View or change the setting described below.

Setting	Description
Programmed Velocity	Move velocity. Units: rmp (rotary) or mm/s (linear).

7.4.3: Programmed Current

View or change the settings described below.

Setting	Description
Programmed Current	Current applied during the constant velocity portion of the move. Units: A.
Current Ramp	Acceleration/deceleration current. Units: mA/s.

CHAPTER

8: CAN NETWORK CONFIGURATION

A CANopen network can support up to 127 nodes. Each node must have a unique and valid seven-bit address (Node ID) in the range of 1-127. (Address 0 should only be used when the amplifier is serving as a CME 2 serial port multi-drop gateway.)

If the amplifier is under DeviceNet control, see *Copley DeviceNet Programmer's Guide*.

Configure a CAN interface

- 1 Verify that the CAN network has been cabled and terminated as per amplifier documents.

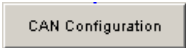
- 2  Click CAN Configuration to open the *CAN Configuration* screen. (If CAN is not the Position Loop Input, choose **Amplifier**→**Network Configuration** instead.)

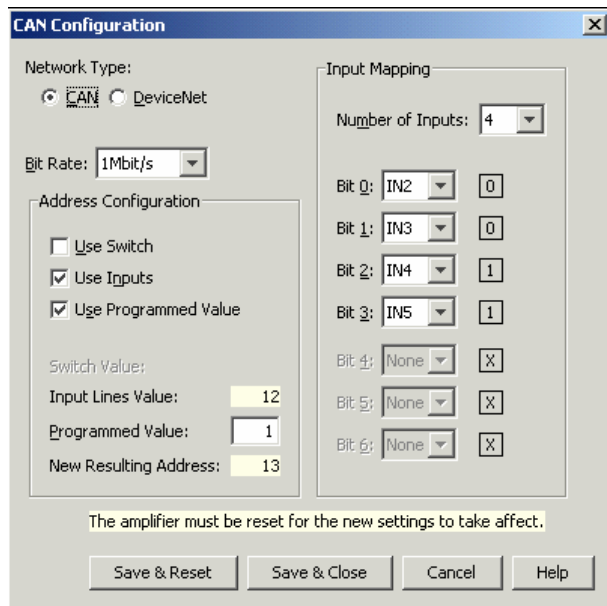

(Note that options may vary based on amplifier model and configuration.)

- 3 Choose network type (CAN or DeviceNet).
- 4 Choose a Bit Rate and choose any combination of address sources (Switch, Inputs, and Programmed Value). The address is the sum of the values from these sources.
- 5 For each source selected, perform the additional steps described below.

Source	Additional Steps
Use Switch	Verify the S1 switch setting. (Assigns values for Bit 0 – Bit 3 of CAN address.)
Use Inputs	Enter Number of Inputs . Choose an input to represent each CAN address bit.
Use Programmed Value	Enter the Programmed value .

- 6 Click **Save & Reset** to save changes to amplifier flash, close the screen, and reset the amplifier. Click **Save & Close** to save changes to amplifier flash without resetting. NOTE: Address and bit rate changes take effect only after power-up or reset.

CHAPTER

9: FAULTS

This chapter shows how to configure the amplifier's fault latching. Perform the basic steps outlined below. Details follow in the chapter:

1

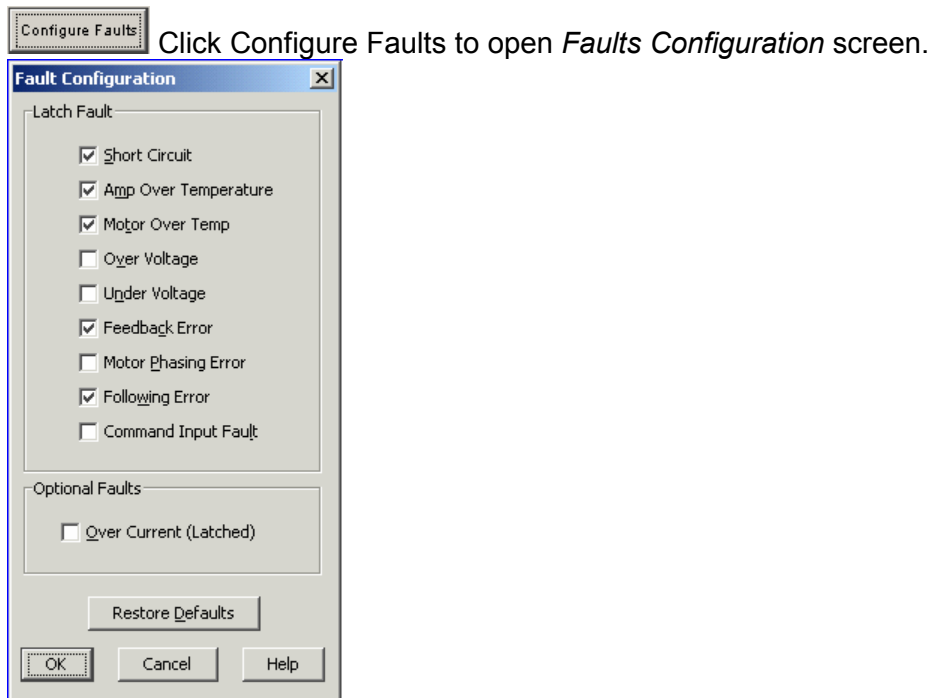

2

Select the faults to latch. See [Fault Configuration Parameters \(p. 70\)](#).

3

Click **OK** to close screen and save changes to amplifier RAM.

4



On the Main screen, click **Save to Flash** to avoid losing the changes.



DANGER

Risk of unexpected motion with non-latched faults.

After the cause of a non-latched fault is corrected, the amplifier re-enables the PWM output stage without operator intervention. In this case, motion may re-start unexpectedly. Configure faults as latched unless a specific situation calls for non-latched behavior. When using non-latched faults, be sure to safeguard against unexpected motion.

Failure to heed this warning can cause equipment damage, injury, or death.

9.1: Fault Configuration Parameters

Each of the following faults can be latched by selecting it on the *Fault Configuration* screen. For more information on latching, see [Fault Latching Notes \(p. 71\)](#). For details on limits and ranges, see the amplifier documentation.

Note: The list of faults may vary with amplifier model.

Fault Description	Fault Occurs When...	Fault is Corrected When...
*Amp Over Temperature	Amplifier's internal temperature exceeds specified temperature.	Amplifier's internal temperature falls below specified temperature.
Motor Phasing Error	Encoder-based phase angle does not agree with Hall switch states. This fault can occur only with brushless motors set up using sinusoidal commutation. It does not occur with resolver feedback or with Halls correction turned off.	Encoder-based phase angle agrees with Hall switch states. See Trouble Shoot Manual Phase w/ Encoder and Halls (p. 91) .
*Feedback error	Over current condition detected on output of the internal +5 Vdc supply used to power the feedback. Resolver or analog encoder not connected or levels out of tolerance. Differential signals from incremental encoder not connected.	Encoder power returns to specified voltage range. Feedback signals stay within specified levels. Differential signals connected.
*Motor Over Temp	Motor over-temperature switch changes state to indicate an over-temperature condition.	Temperature switch changes back to normal operating state.
Under Voltage	Bus voltage falls below specified voltage limit.	Bus voltage returns to specified voltage range.
Over Voltage	Bus voltage exceeds specified voltage limit.	Bus voltage returns to specified voltage range.
*Following Error	User set following error threshold exceeded.	See Position and Velocity Error Notes (p. 72) .
*Short Circuit Detected	Output to output, output to ground, internal PWM bridge fault.	Short circuit has been removed.
Command Input Lost	PWM or other command signal not present.	Command signal restored.
Over Current (Latched)	Output current I ² T limit has been exceeded.	Amplifier is reset and re-enabled.
*Latched by default.		

9.2: Fault Latching Notes

9.2.1: Clearing Non-Latched Faults

The amplifier clears a non-latched fault, without operator intervention, as soon as the fault condition is corrected.



DANGER

Risk of unexpected motion with non-latched faults.

After the cause of a non-latched fault is corrected, the amplifier re-enables the PWM output stage without operator intervention. In this case, motion may re-start unexpectedly. Configure faults as latched unless a specific situation calls for non-latched behavior. When using non-latched faults, be sure to safeguard against unexpected motion.

Failure to heed this warning can cause equipment damage, injury, or death.

9.2.2: Clearing Latched Faults

A latched fault is cleared only after the fault has been corrected and at least one of the following actions has been taken:

- Power-cycle the amplifier
- Cycle (disable and then enable) an enable input that is configured as *Enables with Clear Faults* or *Enables with Reset*
- Access the *CME 2 Control Panel* and press **Clear Faults** or **Reset**
- Clear the fault over the CANopen network or serial bus

9.2.3: Example: Non-Latched vs. Latched Faults

For example, the amplifier temperature reaches the fault temperature level and the amplifier reports the fault and disables the PWM output. Then, the amplifier temperature is brought back into operating range. If the *Amp Over Temperature* fault is not latched, the fault is automatically cleared and the amplifier's PWM outputs are enabled. If the fault is latched, the fault remains active and the amplifier's PWM outputs remain disabled until the faults are specifically cleared (as described above).

9.3: Position and Velocity Error Notes

9.3.1: Error-Handling Methods

In position mode, any difference between the limited position output of the trajectory generator and the actual motor position is a position error. The amplifier's position loop uses complementary methods for handling position errors: following error fault, following error warning, and a position-tracking window.

To set position error handling parameters for servo amplifiers, see [Enter basic Position Loop settings \(p. 106\)](#). For stepper amplifiers, see [Set Position Limits in Stepper Mode \(p. 123\)](#).

Likewise, in velocity or position mode, any difference between the limited velocity command and actual velocity is a velocity error. The amplifier's velocity loop uses a velocity tracking window method to handle velocity errors. (There is no velocity error fault.)

To set parameters for velocity error handling, see [Enter basic Velocity Loop settings \(p. 102\)](#).

9.3.2: Following Error Faults

When the position error reaches the programmed *fault* threshold, the amplifier immediately faults. (The following error fault can be disabled.)

For detailed information, see [Following Error Fault Details \(p. 73\)](#).

9.3.3: Following Error Warnings

When the position error reaches the programmed *warning* threshold, the amplifier immediately sets the *following error warning bit* in the status word. This bit can be read over the CAN network. It can also be used to activate a digital output.

9.3.4: Position and Velocity Tracking Windows

When the position error exceeds the programmed *tracking window* value, a status word bit is set. The bit is not reset until the position error remains within the tracking window for the programmed *tracking time*.

A similar method is used to handle velocity errors.

For detailed information, see [Tracking Window Details \(p. 74\)](#).

9.3.5: Following Error Fault Details

Position Error Reaches Fault Level

As described earlier, position error is the difference between the limited position output of the trajectory generator and the actual position. When position error reaches the programmed *Following Error Fault* level, the amplifier faults (unless the following error fault is disabled.) As with a warning, a status bit is set. In addition, the fault is recorded in the error log. See [Error Log \(p. 155\)](#).

Additional responses and considerations depend on whether the fault is non-latched or latched, as described below.

Amplifier Response to Non-Latched Following Error Fault

When a non-latched following error fault occurs, the amplifier drops into velocity mode and applies the *Fast Stop Ramp* deceleration rate to bring the motor to a halt. The amplifier PWM output stage remains enabled, and the amplifier holds the velocity at zero, using the velocity loop.

Resuming Operations After a Non-Latched Following Error Fault

The clearing of a non-latched following error depends on the amplifier's mode of operation. Issuing a new trajectory command over the CAN bus, the ASCII interface, or DeviceNet will clear the fault and return the amplifier to normal operating condition.

If the amplifier is receiving position commands from the digital or differential inputs, then the amplifier must be disabled and then re-enabled using the amplifier's enable input or through software commands. After re-enabling, the amplifier will operate normally.

Amplifier Response to a Latched Following Error Fault

When a latched following error fault occurs, the amplifier disables the output PWM stage without first attempting to apply a deceleration rate.

Resuming Operations After a Latched Following Error Fault

A latched following error fault can be cleared using the steps used to clear other latched faults:

- Power-cycle the amplifier
- Cycle (disable and then enable) an enable input that is configured as *Enables with Clear Faults* or *Enables with Reset*
- Access the *CME 2 Control Panel* and press **Clear Faults** or **Reset**
- Clear the fault over the CANopen network or serial bus

9.3.6: Tracking Window Details

Proper Tracking Over Time

As described earlier, position error is the difference between the limited position output of the trajectory generator and the actual position. Velocity error is the difference between commanded and actual velocity.

When the position or velocity error exceeds the programmed *tracking window* value, a status word bit is set. The bit is not reset until the error remains within the tracking window for the programmed *tracking time*.

Velocity Tracking Illustration

The following diagram illustrates the use of tracking window and time settings in velocity mode.

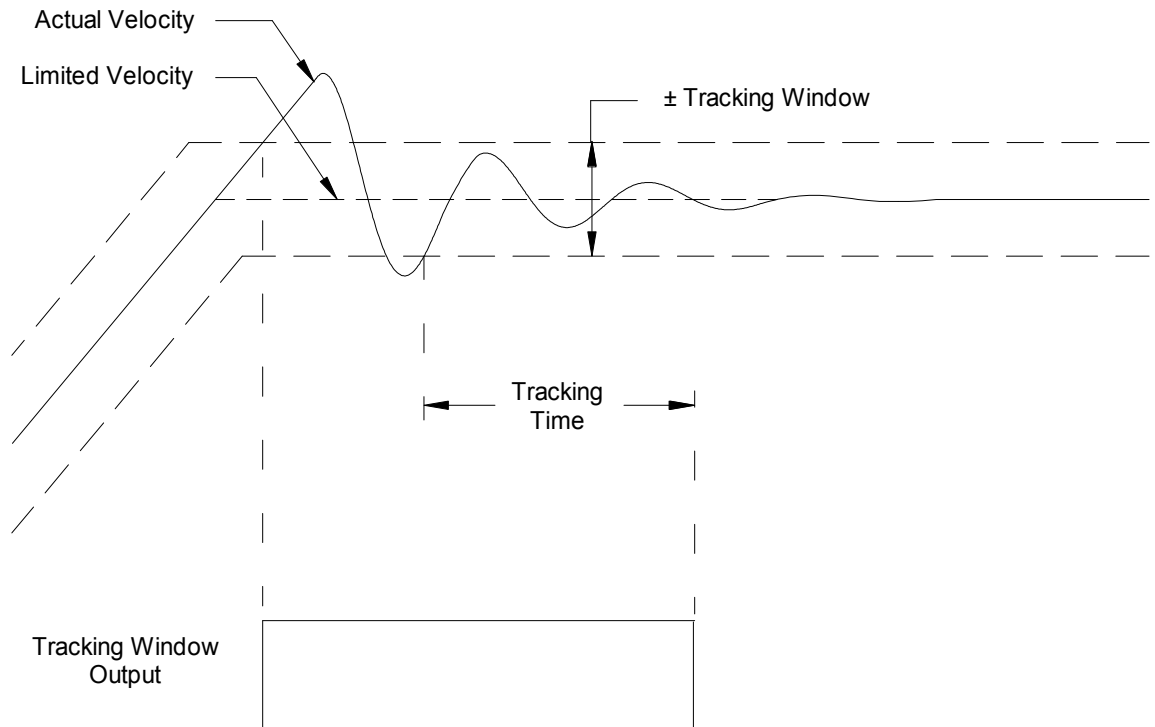

CHAPTER

10: MOTOR PHASING

This chapter shows how to phase the motor using the Auto Phase or Manual Phase tool. Perform the basic steps outlined below. Details follow in the chapter.

Use the procedure described in this chapter to
[Phase Motor with Auto Phase \(p. 76\)](#).

OR

Use the procedure described in this chapter to
[Phase Motor Manually \(p. 86\)](#).

10.1: Phase Motor with Auto Phase

Choose the appropriate procedure:

[Auto Phase Example: Servo Amplifier \(p. 76\)](#)

[Auto Phase Example: Stepper Amplifier, No Encoder \(p. 80\)](#)

[Auto Phase Example: Stepper Amplifier with Encoder, in Stepper Mode \(p. 81\)](#)

[Auto Phase Example: Stepper Amplifier with Encoder, in Servo Mode \(p. 82\)](#)

NOTE: The examples in this chapter show particular amplifier operating modes and motor feedback configurations. Some screens and choices may vary from those described here.

10.1.1: Auto Phase Example: Servo Amplifier

Perform the following steps to Auto Phase a servo amplifier.

NOTE: The following steps show Auto Phase with a brushless rotary motor, digital Halls, and an incremental quadrature encoder. Screens vary for other configurations.

1 Verify that the Enable Input is not activated and that HV or AC power is applied.

2  Click **Auto Phase** to open the *Auto Phase Motor Direction Setup* screen.

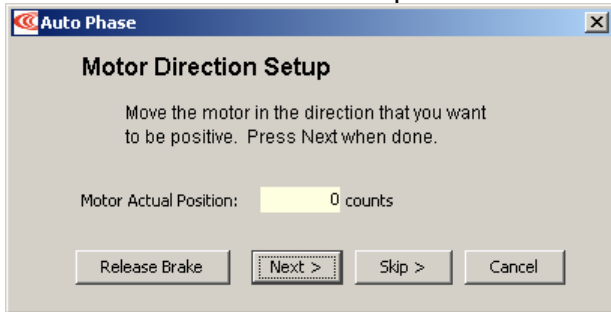

3 Move the motor in the direction to be considered positive OR if you cannot move the motor, click **Skip** (you will confirm motor direction later).
NOTE: If an output is configured as a brake you can temporarily release the brake by holding down the **Release Brake** button. The brake will be reactivated when you release the button.

4 Click **Next** to open the *Auto Phase Motor Wiring Setup* screen:

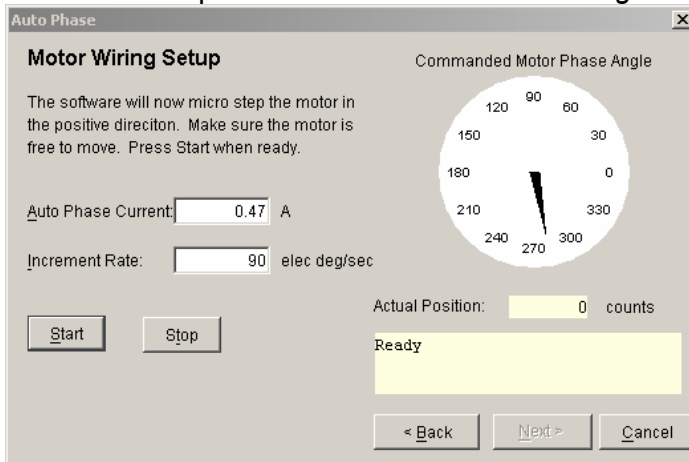

Continued...

...Continued:

- 5 Activate the Enable Input.
- 6 Click **Start** to begin the motor wiring setup.
The message area displays messages: *Configuring Initial Settings, Microstepping, Test Complete, Motor Wiring has been configured.*

During microstepping, a current vector is applied to the motor windings and microstepped through an electrical cycle at a set rate, causing the motor to move.

If you chose to **Skip** the motor direction setup step, Auto Phase will prompt for confirmation of correct motor direction.

If the step fails see [Motor wiring setup problems \(p. 85\)](#).

NOTE: If incorrect values were entered for inductance and resistance, the calculated Cp and Ci values may produce current loop oscillation, evidenced by an audible high frequency squeal during auto phasing.

- 7 Click **Next** to open the *Auto Phase Phase Count Test* screen.

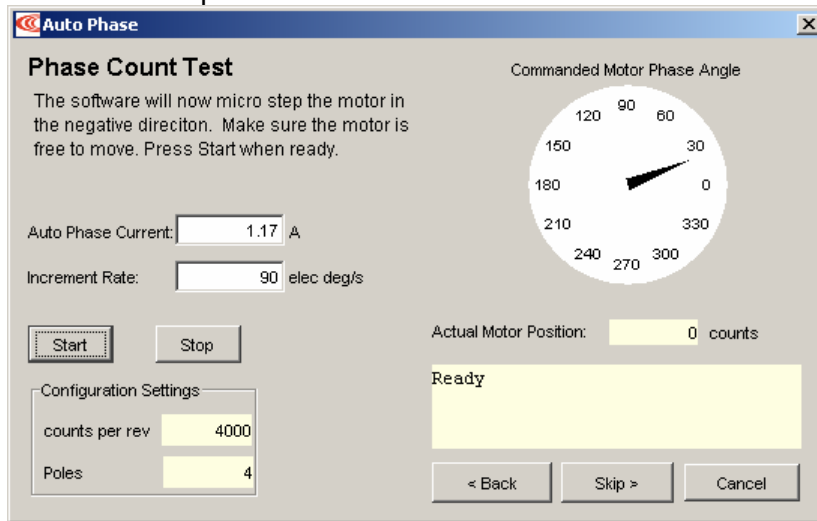

- 8 Click **Start** to begin the Phase Count Test. Observe status messages. See the prompt:

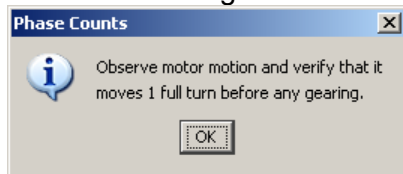

Continued...

...Continued:

- 9 When you are ready to observe motion, click **OK**. See the prompt:

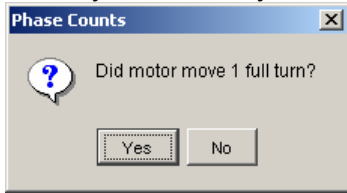

- 10 If motor did not turn 1 full turn, click **No** and see [Phase count test problems \(p. 85\)](#).

If motor turned 1 full turn, click **Yes**.

The message area displays progress and completion messages.

- 11 For a resolver (–R) version of a Copley Controls amplifier, skip to [Step 13 \(p. 79\)](#). For a non-resolver amplifier, click **Next** to open the *Hall Wiring Setup* screen.

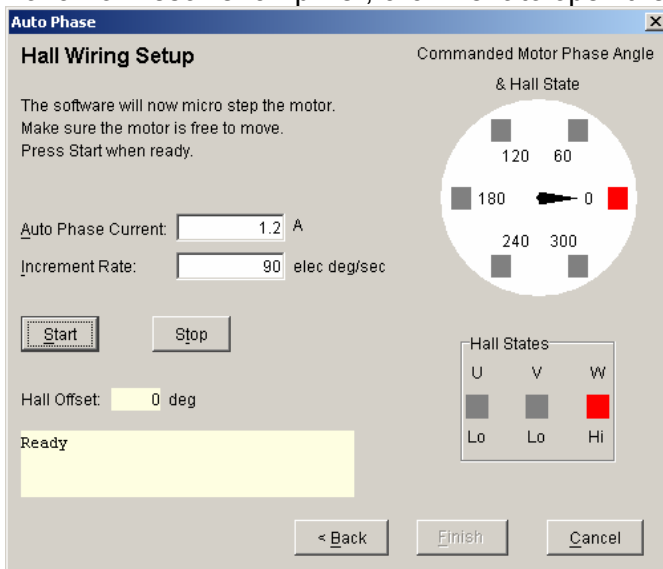

- 12 Click **Start** to begin the Halls wiring setup. The message area displays the messages: *Microstepping. Test Complete. Motor has been properly phased.*

During microstepping, a current vector is applied to the motor windings and microstepped through an electrical cycle at a set rate, causing the motor to move. As the motor moves the Hall lines are decoded for proper commutation.

If the step fails, see [Halls wiring setup problems \(p. 85\)](#).

Continued...

...Continued:

- 13** For a resolver (-R) version of a Copley Controls amplifier, click **Next** to open the Resolver Phase Angle Setup screen.

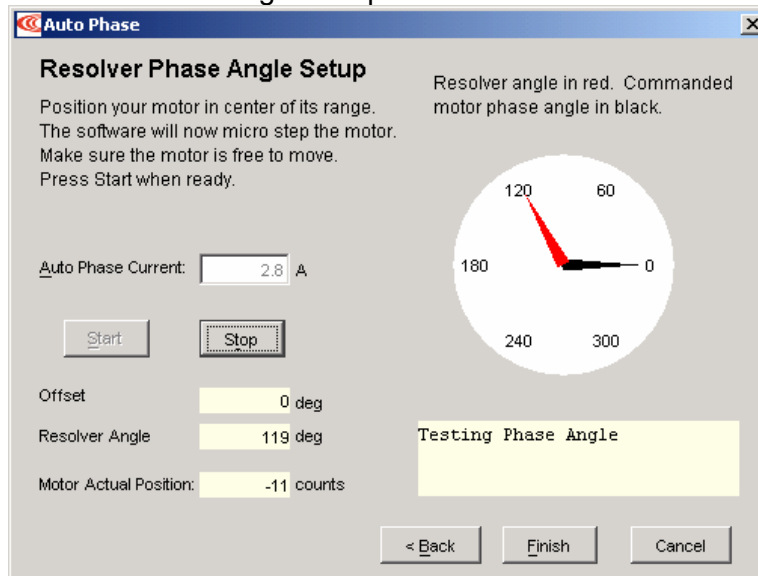

- 14** Click **Start** to start the resolver phase angle setup. The message area displays status messages.
- 15** Click **Finish** to close the screen and save values to flash memory OR to close the screen without saving changes, click **Cancel**.
- 16** If the Auto Phase algorithm does not produce desired results, try adjusting the Auto Phase Current and Increment Rate values, using the guidelines in [Guidelines for Choosing Auto Phase Current and Increment Rate Values \(p. 85\)](#).
- 17** If desired results are not obtained, or to confirm results, proceed to [Phase Motor Manually \(p. 86\)](#).
-

10.1.2: Auto Phase Example: Stepper Amplifier, No Encoder

1 Verify that the Enable Input is not activated and that HV power is applied.

2



Click **Auto Phase** to open the *Auto Phase Motor Direction Setup* screen.

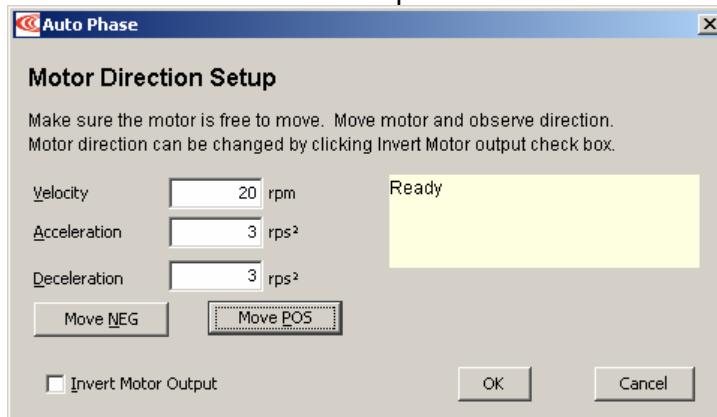

3 Hold down **Move POS** to move the motor in the direction considered positive, and observe the direction of movement.

If the motor does not move see [Motor wiring setup problems \(p. 85\)](#).

4 If the motor moved opposite the direction that you wish to program as positive, click **Invert Motor Output**.

5 Click **OK** to save the direction setting.

10.1.3: Auto Phase Example: Stepper Amplifier with Encoder, in Stepper Mode

1 Verify that the Enable Input is not activated and that HV power is applied.

2



Click **Auto Phase** to open the *Auto Phase Motor Direction Setup* screen.

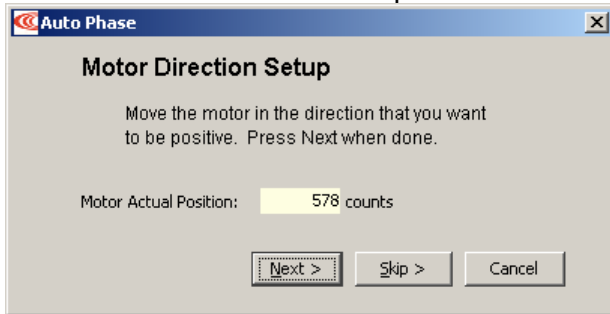

3 Move the motor in the direction you wish to be considered positive.

4 Activate the Enable Input.

5 Click **Next** to open the *Auto Phase Motor Wiring Setup* screen.

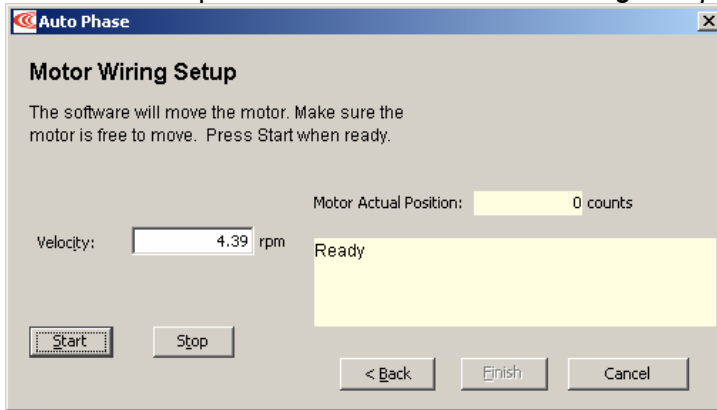

6 Click **Start** to begin motor wiring setup with default values. After successful motor wiring setup, the message “Test Complete” appears.

7 Click **Finish** to close the screen and save values to flash memory.

10.1.4: Auto Phase Example: Stepper Amplifier with Encoder, in Servo Mode

1 Verify that the Enable Input is not activated and that HV power is applied.

2



Click **Auto Phase** to open the *Auto Phase Motor Direction Setup* screen.

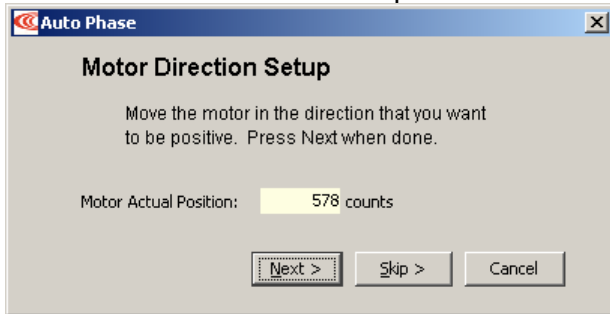

3 Move the motor in the direction you wish to be considered positive.

4 Activate the Enable Input.

5 Click **Next** to open the *Auto Phase Motor Wiring Setup* screen.

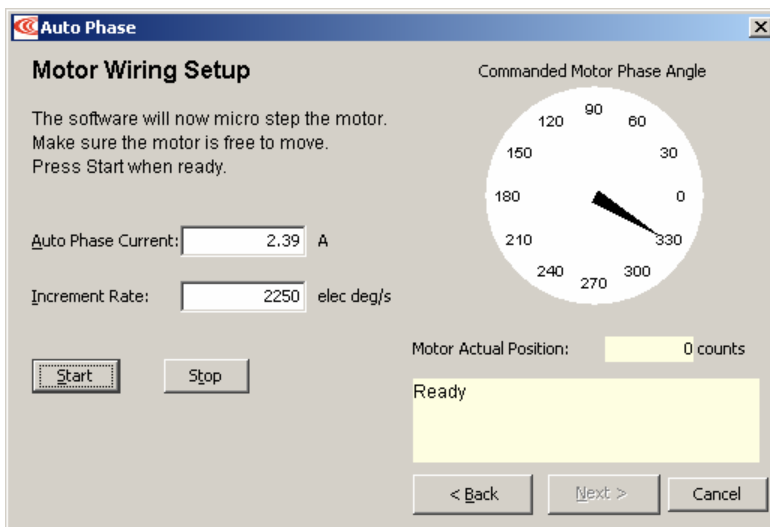

Continued...

...Continued:

- 6 Click **Start** to begin the motor wiring setup. The message area displays messages: *Configuring Initial Settings, Microstepping, Test Complete, Motor Wiring has been configured.*

During microstepping, a current vector is applied to the motor windings and microstepped through an electrical cycle at a set rate, causing the motor to move.

If you chose to **Skip** the motor direction setup step, Auto Phase will prompt for confirmation of correct motor direction.

If the step fails see [Motor wiring setup problems \(p. 85\)](#).

NOTE: If incorrect values were entered for inductance and resistance, the calculated Cp and Ci values may produce current loop oscillation, evidenced by an audible high frequency squeal during auto phasing.

- 7 Click **Next** to open the *Auto Phase Phase Count Test* screen.

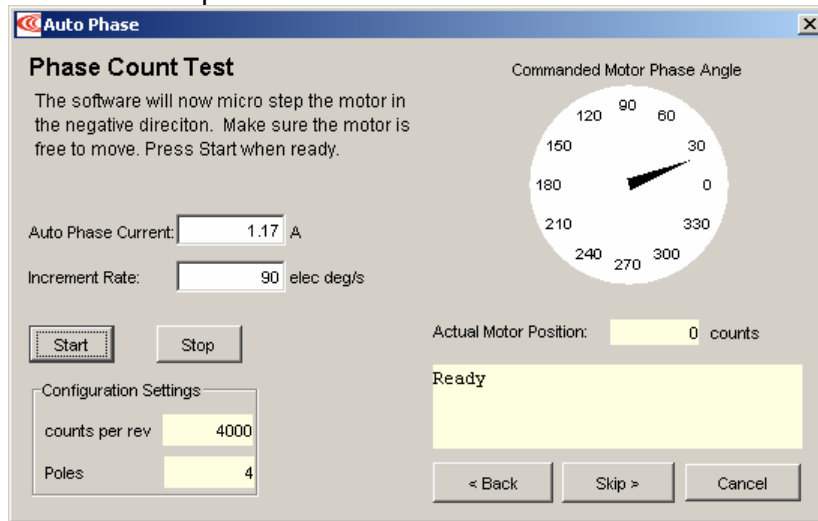

- 8 Click **Start** to begin the Phase Count Test. Observe status messages. See the prompt:

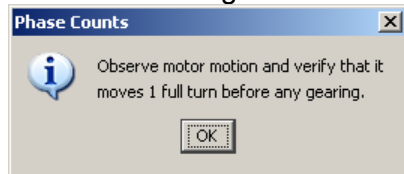

- 9 When you are ready to observe motion, click **OK**. See the prompt:

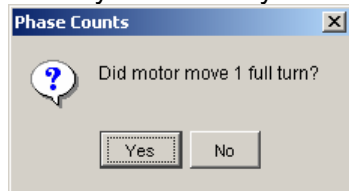

- 10 When you are ready to observe motion, click **OK**. See the prompt:

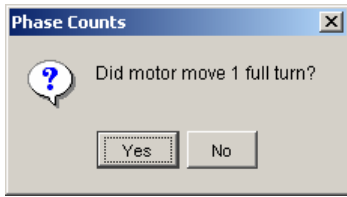

- 11 Click **Next** to open the *Auto Phase Motor Phase Initialize* screen:

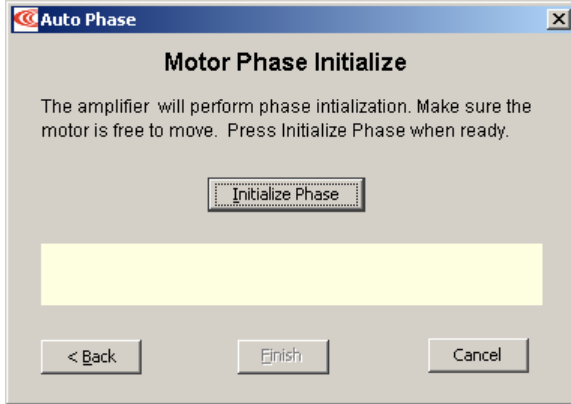

- 12 Click **Initialize Phase** to start phase initialization. If successful, this message appears: "Test Complete. Phasing has been initialized."

- 13 Click **Finish** to close the screen and save values to flash memory.

- 14 After clicking **Finish**, the following message appears if changes were made:

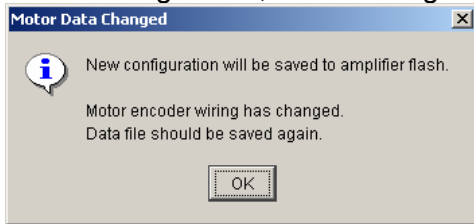

- 15 Click **OK**.
-

10.2: Guidelines for Choosing Auto Phase Current and Increment Rate Values

Here are some considerations in choosing Auto Phase Current and Increment Rate values:

- If friction is high, then more current may be required to move the load.
- High static friction may require more current to overcome stiction.
- Transition from static friction to dynamic friction, and back, may produce jerky motion.
- A faster rate will operate in the dynamic friction range.
- A slower rate will operate in the static friction range.
- If the friction is low, as in the case of air bearings, low frequency oscillations may occur; thus, less current and slower rates may be required. If oscillations persist, then friction may need to be temporarily added.

10.3: Trouble Shoot the Auto Phase Process

1 Motor direction setup problems

If motor direction setup step failed:

- Check Encoder or resolver power and signals.
- Verify that the encoder is differential. (Contact factory if encoder is single-ended.)
- Check shielding for proper grounding.

2 Motor wiring setup problems

If motor wiring setup step failed:

- Verify that amplifier is disabled.
- Check for mechanical jamming.
- Check for smooth motion with no mechanical jerking.
- Check for good connections to the motor power wires.
- Disconnect motor power wires and measure for proper motor resistance.

3 Phase count test problems

If phase count test failed, verify that in the Motor/Feedback screen the following parameters have been set correctly:

- Number of Poles for rotary motors. See [Verify the motor's pole count \(p. 91\)](#).
- Magnetic Pole Pair Length for linear motors
- Encoder Lines or Fundamental Lines for rotary encoders.
- Encoder Resolution for linear encoders.

4 Halls wiring setup problems

If Halls wiring setup step failed:

- Check Halls power and signals.
 - Check for smooth motion with no mechanical jerking.
 - Check shielding for proper grounding.
-

If the auto phase procedure fails despite these corrective measures, see [Phase Motor Manually \(p. 86\)](#).

10.4: Phase Motor Manually

The CME 2 Manual Phase tool lets the user phase a brushless motor, monitor signals, check configuration wiring, and control a microstepping current vector.

10.4.1: Manual Phase Example: Motor with Encoder

- 1 Make sure that no load is attached to the motor.
- 2 On the *Main* screen, choose **Tools**→**Manual Phase** to open the window:

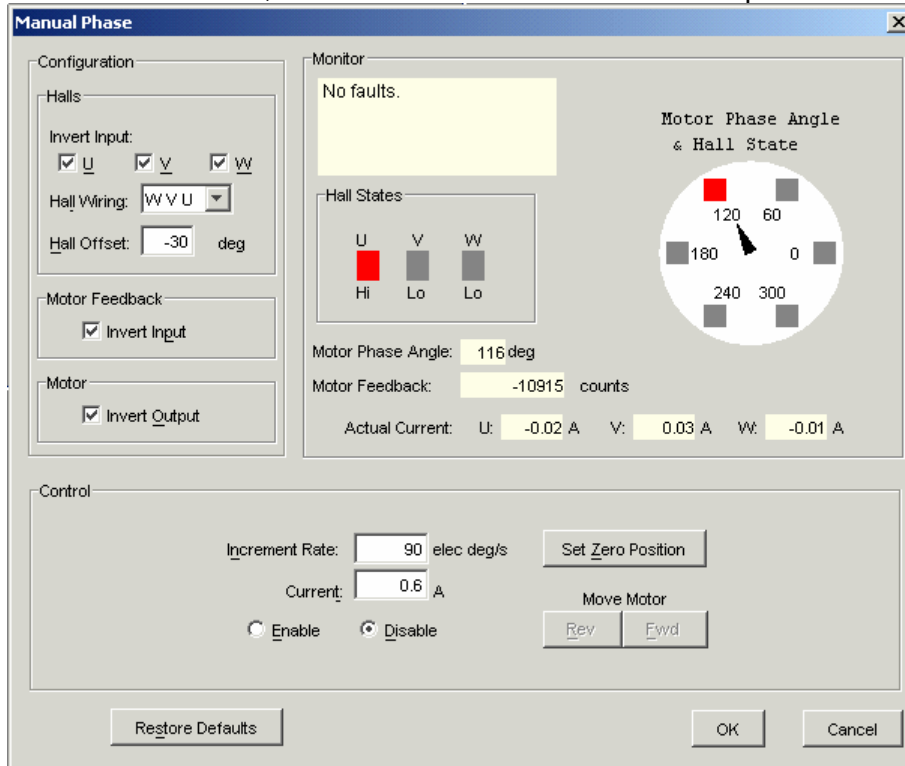

- 3 

Verify the **Current** setting and then enable the amp by selecting **Enable** in the Control area of the Manual Phase window.

- 4 

To control the current vector rotation, command the motor forward or reverse.
 NOTE: Some motors have bearings stiction, so helping the motor with mechanical force is acceptable. Motors with no friction may need friction added to steady motion.

- 5 If the motor cannot keep up with the rate of vector rotation, then reduce the *Increment Rate* or increase the *Current*.
- 6 Verify that pressing forward button moves motor forward.
 If the motor moves in the wrong direction, toggle the **Motor Invert Output** setting.

Continued...

...Manual Phase Example: Motor with Encoder, continued:

- 7 Verify actual position count agrees with direction of rotation: increasing counts in forward direction and decreasing counts in reverse direction. If it does not, toggle the Motor Feedback Invert Input box setting.
- 8 If the motor has no Halls, skip to [Phase Initialization Steps for Motor without Halls \(p. 88\)](#).

9 Monitor the vector rotation through one electrical cycle for proper Hall transitions:

- Verify that the red indicator rotates in the same direction as the motor phase angle, and that the transition occurs when the needle is between indicators (± 30 degrees, as shown below).

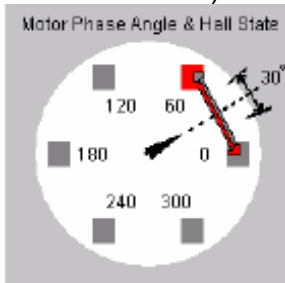

- If the needle and Hall states do not track properly, use the *Hall Wiring* list box and/or Invert Input options (shown below) to swap the amplifier's Hall wire configuration.

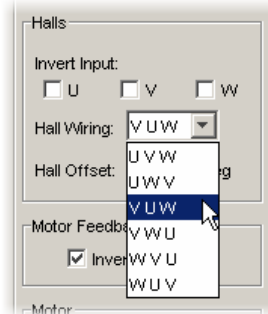

- If the red indicator transition leads or lags behind the centered needle by more than 30 degrees, then try adjusting the *Hall Offset* in +/- 30 degree increments:



10 Phasing of a motor with encoder and Halls is complete. Click **OK**.

Phase Initialization Steps for Motor without Halls

The Phase Initialization function is designed to phase a motor with no Halls.



Halls are strongly recommended for safe, redundant system.

Copley strongly recommends the use of Halls or a commutating encoder for commutation to provide a safe, redundant system. If the application requires otherwise, the customer accepts responsibility for verifying system performance and reliability.

DANGER

Failure to heed these warnings can cause equipment damage, injury, or death.

The Phase Initialization function uses as little motion as possible (less than 1/3 of one electrical cycle) to determine phasing. Phase Initialization drives the motor in open loop current mode, using microstepping of a current vector.

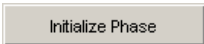
- 1 This procedure is a continuation of [Manual Phase Example: Motor with Encoder \(p. 86\)](#). Before proceeding, verify you have completed that procedure through [Step 8 \(p. 87\)](#).
- 2 Ensure that the motor is free to move (for instance, make sure the brake is OFF).
- 3 Ensure that no external force, such as gravity, will cause the motor to move. If it is not practical to eliminate such forces, it may be necessary to use the **Forced Phase** feature later in this procedure.
- 4  To phase a motor with an encoder and no Halls, click **Initialize Phase**. Observe the status messages under *Monitor*.
- 5 If the message “Phase Initialized” appears, the phasing of a motor with encoder and no Halls is complete. Click **OK** to close the *Manual Phase* window.

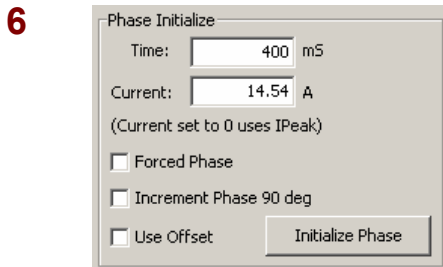

If the phasing function fails (for instance, message “Phase Initialized” is not displayed, or if a phasing fault is indicated) adjust the phase initialization settings described below and try Step 4 (**Initialize Phase**) again.

Setting	Description
Time	Used first as a delay, allowing amplifier to ramp up current to drive a small move. Then used as a settling time. If the value is too low, the settling may not occur in time, possibly resulting in jerky motion. Default: 400 mS.
Current	Use to overcome stiction when rotating current vector. If the current is too large, motion may not settle; a low value may not provide enough current to drive a move.
Forced Phase	When selected, Forced Phase causes the Phase Initialization function to apply Phase Init Current to alternate pairs of motor wires using the Phase Init Time. Forced Phasing has been used to overcome various phasing problems, including situations where gravity introduces unwanted motion. Forced Phasing tends to produce more jerk and apparent motion.
Increment Phase 90 deg	If set, the amplifier will increase the starting phase angle by 90 degrees after every failed initialization attempt.
Use Offset	If set, the amplifier uses the Hall Offset value as the initialization starting angle.

10.4.2: Manual Phase Example: Motor with Resolver

- 1 Make sure that no load is connected to the motor.
- 2 On the *Main* screen, choose **Tools**→**Manual Phase** to open the window:

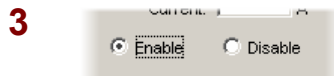
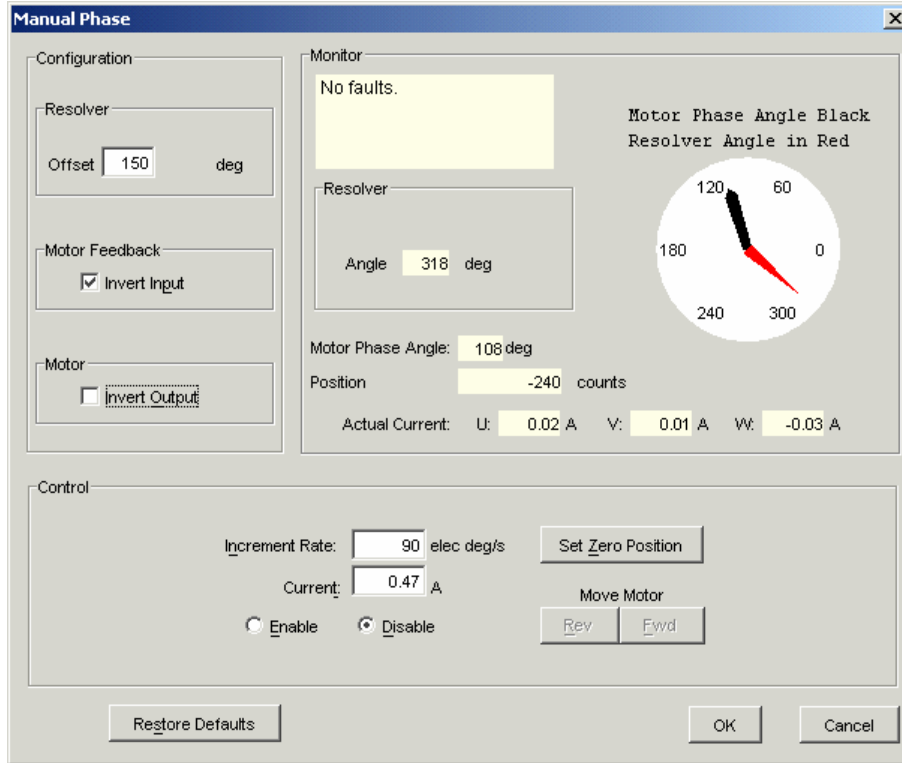

Verify the **Current** setting and then enable the amp by selecting **Enable** in the Control area of the Manual Phase window.

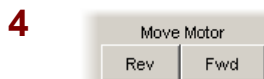

To control the current vector rotation, command the motor forward or reverse.
 NOTE: Some motors have bearings stiction, so helping the motor with mechanical force is acceptable. Motors with no friction may need friction added to steady motion.

- 5 If the motor cannot keep up with the rate of vector rotation, then reduce the *Increment Rate* or increase the *Current*.
- 6 Verify that pressing forward button moves motor forward. If it does not, toggle the Motor Invert Output box setting.
- 7 Verify actual position count agrees with direction of rotation: increasing counts in forward direction and decreasing counts in reverse direction. If it does not, toggle the Motor Feedback Invert Input box setting.

Continued...

...Manual Phase Example: Motor with Resolver, continued:

- 8 Adjust Resolver Offset configuration as required, testing **Fwd** and **Rev**, to produce alignment of Motor Phase Angle with Resolver Angle as shown here.

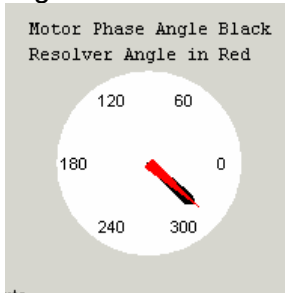

Note: Motor manufacturers typically align the resolver in 30 degree increments, typically by applying current through a pair of motor power wires.

10.5: Trouble Shoot Manual Phase w/ Encoder and Halls

To perform trapezoidal commutation after power-up or reset, the amplifier must receive good Hall signals. After the first Hall transition is detected, then sinusoidal commutation can be performed. In sinusoidal commutation, the amplifier uses the encoder for commutation while monitoring the Halls to verify proper phase. If the error between the encoder count and Hall transition is too large, then the Hall phase correction will not be performed and a phase fault will be triggered.

Test for phase fault problems in the order shown below.

1 Data accuracy test

- Verify the motor's pole count:
 - Apply a current vector at zero Increment Rate to lock motor in position.
 - Turn the motor shaft and count the number of distinct locking positions.
 - Calculate the number of poles: Poles = number of locking positions * 2
- Verify the encoder line count OR a linear motor's magnetic pair length and the encoder resolution.

2 Encoder wiring test

- If the Halls produce good trapezoidal commutation but a phase fault is persistent in sinusoidal commutation mode, the encoder is highly suspect. Try this:
 - Verify the differential encoder signals.
 - Verify proper twisted shielded cable with good grounding.
 - Disable the amplifier and move the motor manually to test for phase fault.
 - If phase fault only occurs under command of current, make sure the motor power cable is not bundled with the encoder cable.

3 Hall signals test

- If you suspect the Halls signals are faulty, try this:
 - Make sure Halls change states as the motor moves through one electrical cycle.
 - Some Hall signals are noisy and require filtering. Check with motor manufacturer.
 - Some Halls are not properly calibrated to the motor manufacturer's specification.

4 Hall transition test

- If you suspect that the location of the Hall transition is not within +/-30 degrees, try this:
 - Adjust Hall offset in smaller increments.
 - Verify Hall alignment.
 - Make sure motion is smooth.
-

CHAPTER

11: CONTROL LOOPS

This chapter shows how to program and tune the control loops. Perform the basic steps outlined below. Details follow in the chapter.

For each control loop:

1  **or**  **or**  Click the appropriate button to open the loop control screen.

2  Change/verify settings as needed.

3  Click **Close** to close screen and save changes to amplifier RAM.

4  Click to open the **Scope** tool.

5  Run a function or profile and adjust settings to tune the loop.



For an overview of control loop theory, see [Servo Operating Modes and Control Loops \(p. 10\)](#).

11.1: Current Loop Setup and Tuning

Initial current loop proportional gain (**Cp**) and current loop integral gain (**Ci**) values can be calculated with [The Calculate Function \(p. 46\)](#).

Enter basic Current Loop settings

1

Click I Loop to open the *Current Loop* screen:

2

Change/verify Current Loop parameters as needed.

Parameter	Description
Peak Current Limit	Used to limit the peak phase current to the motor. Max value depends upon the amplifier model; Min value > continuous limit.
I ² T Time Limit	Sets I ² T Time Limit in mS. See I²T Time Limit Algorithm (p. 163) .
Continuous Current Limit	Used to limit the Phase Current. Max Value is < <i>Peak Current</i> and depends upon the amplifier model. Min value: 0
Current Loop Offset	Sets current loop offset. Leave it set to zero until after tuning. For more information, see Offset (p. 100) .
Cp	Current loop proportional gain. Range 0 – 32,767.
Ci	Current loop integral gain. Range 0 – 32,767.
Drive Output	Maximize Smoothness: Amplifier uses circular vector limiting to produce smooth operation even into the voltage limits. Maximize Speed: Allows for slightly more of the bus voltage to be used when in the voltage limit. This may produce a small disturbance at top speed.
Auto Tune	See Current Loop Auto Tune (p. 97) .
Bandwidth	Measure bandwidth using the Cp and Ci values now in the amplifier.

3

Click **Close** to close screen and save changes to amplifier RAM.

Manually tune the Current Loop

METHOD: Apply square-wave excitation to the current loop and adjust current loop proportional gain (C_p) and current loop integral gain (C_i) to obtain a desired waveform. For instance:

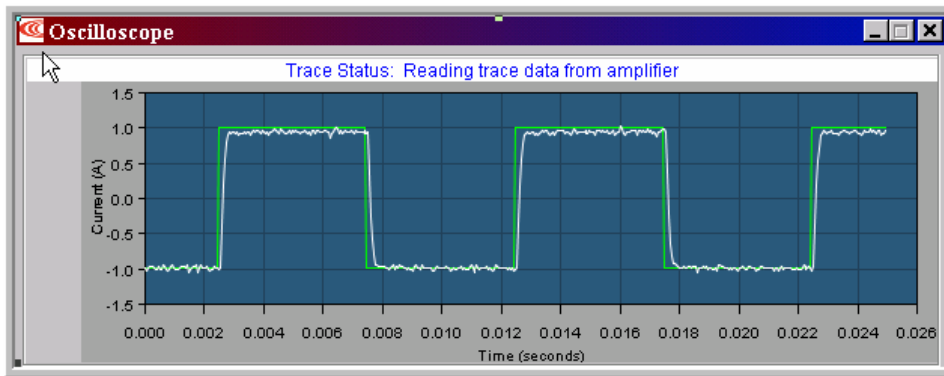

NOTES:

- 1) During tuning, observe any warnings that appear to the left of the trace.
- 2) Some users prefer the Auto Tune feature. See [Current Loop Auto Tune \(p. 97\)](#).

1  Click the Scope Tool.

2  Choose **Current** from the Function Generator *Apply To*: list.

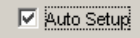
3  On the *Settings* tab, make sure **Auto Setup** is selected. Auto Setup automatically sets the following parameters:

Function Generator Tab	
Parameter	Description
Function	Square Wave.
Amplitude	10% of continuous current value.
Frequency	100 Hz.
Settings Tab	
Channel 1	Commanded current (green).
Channel 2	Actual current (white).

4  Verify that the Amplitude value is not excessive for the motor.

Continued...

...Continued:

5  Click **Start**.

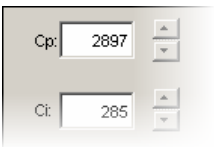
6  On the *Gains* tab, adjust current loop proportional gain (C_p):

- Set current loop integral gain (C_i) to zero.
- Raise or lower C_p to obtain desired step response. (Typically, little or no overshoot with a 100 Hz, low-current square wave.) If the C_p value is too large, ringing may occur. If the C_p value is too low, bandwidth decreases.

7 Adjust current loop integral gain (C_i) until desired settling time is obtained.

8  Press **Stop** to stop the function generator.

9  On the Main screen, click **Save to Flash** to avoid losing the changes.

11.2: Current Loop Auto Tune

Tune the Current Loop with Auto Tune

METHOD: The current loop Auto Tune algorithm applies a square-wave command to the current loop and adjusts current loop proportional gain (C_p) and current loop integral gain (C_i) until a desirable waveform is obtained.

Initial current loop proportional gain (**Cp**) and current loop integral gain (**Ci**) values can be calculated with [The Calculate Function \(p. 46\)](#).

1

Click **I Loop** to open the *Current Loop* screen:

2

Verify that the amplifier is hardware enabled.

3

Click **Auto Tune** to open screen and start the Current Loop Auto Tune.

4

To Change the Auto Tune Current, Press **Stop**, enter the new current in the *Auto Tune Current* field, and then press **Start**.

Continued...

...Tune the Current Loop with Auto Tune, continued:

- 5 Observe the Auto Tune process and results. A typical example:
 - Sets C_p and C_i to zero and then adjusts C_p and C_i for optimal values.

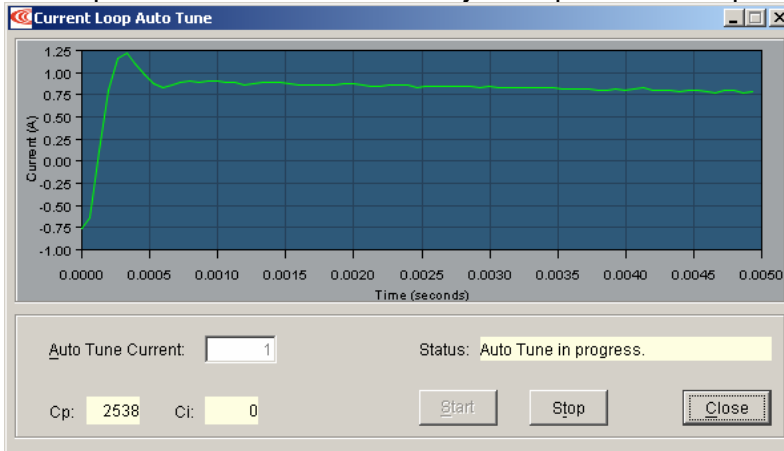

- Uses a frequency sweep to determine the small signal, current loop bandwidth.

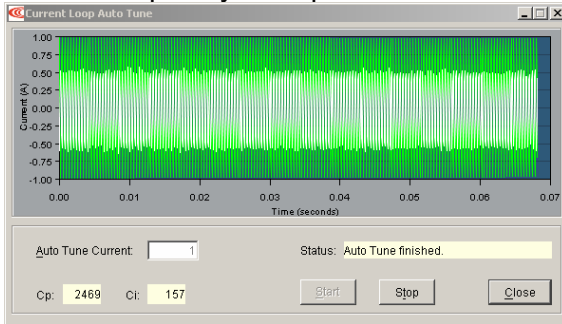

Displays the results: a set of C_p and C_i alternatives, and the bandwidth measured using the high C_p and C_i values.

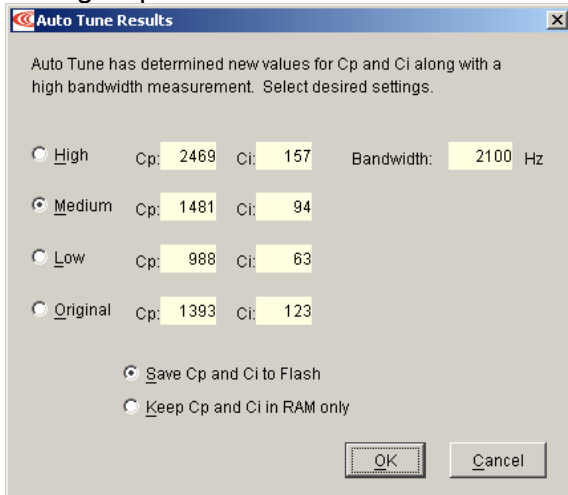

Continued...

...*Tune the Current Loop with Auto Tune, continued:*

- 6** Choose an action based on Auto Tune results.
 - Choose which set of values to save: *High, Medium, Low, or Original*. The *Medium* values, selected by default, are appropriate for most applications.
 - Optionally choose how to save: Save Cp and Ci to Flash or Keep Cp and Ci in amplifier RAM only.
 - 7** Click **OK** to save the values as chosen, and close the *Auto Tune Results* window.
-

11.3: Notes on the Current Mode and Current Loop

11.3.1: Current Loop Diagram

As shown below, the “front end” of the current loop is a limiting stage. The limiting stage accepts a current command, applies limits, and passes a limited current command to the summing junction. The summing junction takes the commanded current, subtracts the actual current (represented by the feedback signal), and produces an error signal. This error signal is then processed using the integral and proportional gains to produce a command. This command is then applied to the amplifier’s power stage.

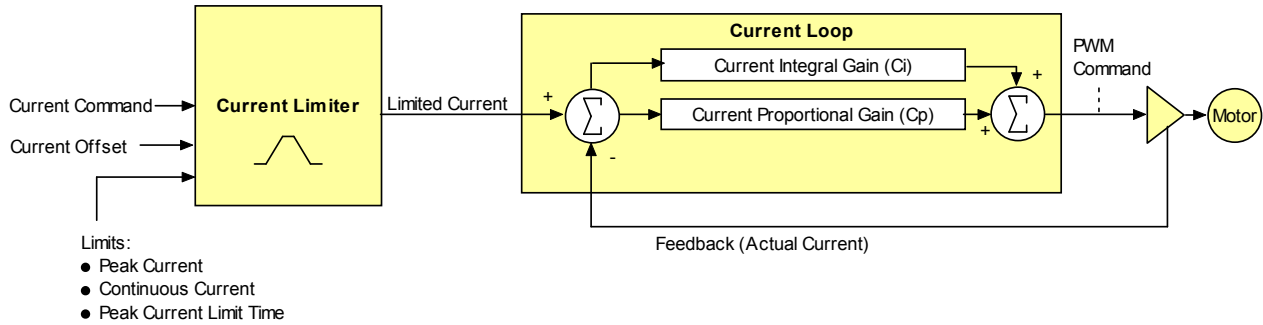

11.3.2: Current Loop Inputs

- The amplifier’s analog or PWM inputs.
- A CANopen network via the amplifier’s CAN interface.
- A Copley Virtual Motion (CVM) control program.
- The amplifier’s internal function generator.

In velocity or position modes, the current command is generated by the velocity loop.

11.3.3: Offset

The current loop offset is intended for use in applications where there is a constant force applied to, or required of, the servomotor and the system must control this force. Typical applications would be a vertical axis holding against gravity, or web tensioning. This offset value is summed with the current command before the limiting stage.

11.3.4: Limits

The current command is limited based on the following parameters:

Limit	Description
Peak Current Limit	Maximum current that can be generated by the amplifier for a short duration of time. This value cannot exceed the peak current rating of the amplifier.
Continuous Current Limit	Maximum current that can be constantly generated by the amplifier.
I ² T Time Limit	Maximum amount of time that the peak current can be applied to the motor before it must be reduced to the continuous limit or generate a fault. For more details, see I²T Time Limit Algorithm (p. 163) . Note: Although the current limits set by the user may exceed the amplifier’s internal limits, the amplifier operates using both sets of limits in parallel, and therefore will not exceed its own internal limits regardless of the values programmed.
Ramp	Rate of change in current command. Used to limit jog moves initiated from the Control Panel Jog function in current mode, and in advanced Indexer Program functions.

11.3.5: Current Loop Gains

The current loop uses these gains:

Gain	Description
Cp - Current loop proportional	The current error (the difference between the actual and the limited commanded current) is multiplied by this value. The primary effect of this gain is to increase bandwidth (or decrease the step-response time) as the gain is increased.
Ci - Current loop integral	The integral of the current error is multiplied by this value. Integral gain reduces the current error to zero over time. It controls the DC accuracy of the loop, or the flatness of the top of a square wave signal. The error integral is the accumulated sum of the current error value over time.

11.3.6: Current Loop Output

The output of the current loop is a command that sets the duty cycle of the PWM output stage of the amplifier.

11.4: Velocity Loop Setup and Tuning

Initial velocity loop proportional gain (**Vp**) and velocity loop integral gain (**Vi**) values can be calculated with [The Calculate Function \(p. 46\)](#).

Enter basic Velocity Loop settings

1

Click V Loop (screen contents vary with model and configuration):

2

Change/verify Velocity Loop parameters as needed.

Parameter	Description
Velocity Limit	Top speed limit. Max value may depend upon the back EMF & the Encoder value. Min value: 0.
Acceleration Limit	Maximum acceleration rate. Max value may depend upon load, inertia, & peak current. Min value: 1. (Does not apply in position mode.)
Deceleration Limit	Maximum deceleration rate. Max value may depend upon load, inertia, & peak current. Min value: 1. (Does not apply in position mode.)
Tracking Window	See Tracking Window Details (p. 74) .
Tracking Time	
Vp	Velocity loop proportional gain. Range: 0 to 32,767.
Vi	Velocity loop integral gain. Range: 0 to 32,767.
Fast Stop Ramp	Deceleration rate used by the velocity loop when the amplifier is hardware disabled. Range: 0 to 100,000,000. Default: velocity loop <i>Decel. Limit</i> value. For more information, see Velocity Loop Limits (p. 104) .
Low Gains Shift	Increases the resolution of the units used to express Vp and Vi, providing more precise tuning. For more information, see Velocity Gains Shift (p. 105) .
Hi Gains Shift	Decreases the resolution of the units used to express Vp and Vi, providing more precise tuning. For more information, see Velocity Gains Shift (p. 105) .
Vi Drain (integral bleed)	Vi drain modifies the effect of velocity loop integral gain. The higher the Vi Drain value, the faster the integral sum is lowered. Range: 0 to 32,000. Default: 0.
Command Filter	Programmable command input filter. Disabled by default. See Velocity Loop Command and Output Filters (p. 105) .
Output Filter	Programmable output filter. Default filter type: Low-Pass, 2-pole Butterworth (Cut Off Frequency 200 Hz). See Velocity Loop Command and Output Filters (p. 105) .

3

Click **Close** to close screen.

Manually Tune the Velocity Loop

METHOD: Apply square-wave excitation to velocity loop and adjust proportional gain (V_p) and integral gain (V_i) to obtain desired waveform. For instance:

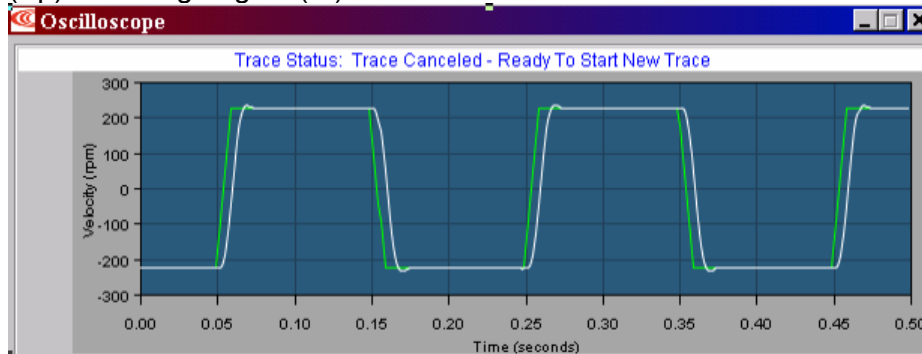

NOTE: During tuning, observe any warnings that appear to the left of the trace.

1



Click the Scope Tool.

2

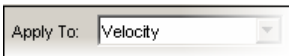

Choose **Velocity** from the Function Generator *Apply To*: list.

3

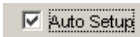

On the *Settings* tab, make sure **Auto Setup** is selected.

Auto Setup automatically sets the following parameters:

Function Generator Tab	
Parameter	Description
Function	Square Wave.
Amplitude	10% of maximum velocity value.
Frequency	5 Hz.
Settings Tab	
Channel 1	Limited velocity (green).
Channel 2	Actual Motor Velocity (white).

4



Verify that Amplitude value is not excessive for the motor.

5



Click **Start**.

6

On the *Gains* tab, adjust velocity loop proportional gain (V_p):

- Set velocity loop integral gain (V_i) to zero.
- Raise or lower proportional gain (V_p) to obtain desired step response. (Typically, little or no overshoot on a 5 Hz small, slow-speed square wave.)

7

Adjust velocity loop integral gain (V_i) until desired settling time is obtained.

8



Press **Stop** to stop the function generator.

9



On the Main screen, click **Save to Flash** to avoid losing the changes.

11.5: Notes on the Velocity Mode and Velocity Loop

11.5.1: Velocity Loop Diagram

As shown below, the velocity loop limiting stage accepts a velocity command, applies limits, and passes a limited velocity command to the input filter. The filter then passes a velocity command to the summing junction. The summing junction subtracts the actual velocity, represented by the feedback signal, and produces an error signal. (The velocity loop feedback signal is always from the motor feedback device even when an additional encoder is attached to the load.) The error signal is then processed using the integral and proportional gains to produce a current command. Programmable digital filters are provided on both the input and output command signals.

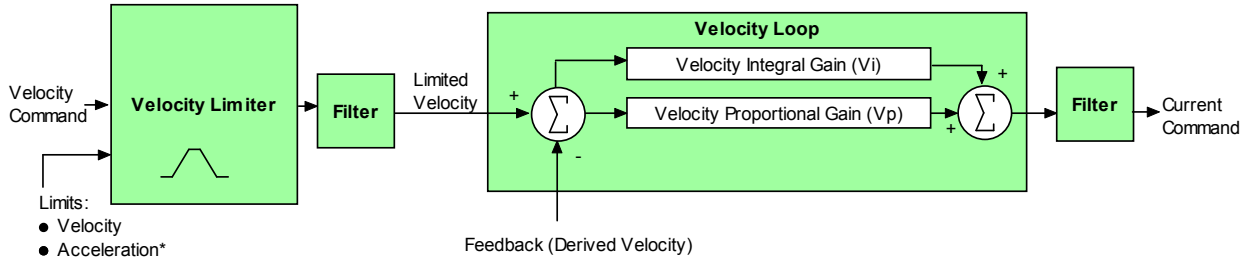

- Limits:
- Velocity
 - Acceleration*
 - Deceleration*
 - Emergency Stop Deceleration*

*Not used when velocity loop is controlled by position loop. See "Velocity Loop Limits" for details.

11.5.2: Inputs

In velocity mode, the velocity command comes from one of the following:

- The amplifier's analog or PWM inputs.
- A CANopen network via the amplifier's CAN interface.
- A Copley Virtual Motion (CVM) control program.
- The amplifier's internal function generator.

In position mode, the velocity command is generated by the position loop.

11.5.3: Velocity Loop Limits

The velocity command is limited based on the following set of parameters designed to protect the motor and/or the mechanical system.

Limit	Description
Velocity Limit	Sets the maximum velocity command input to the velocity loop.
Acceleration Limit	Limits the maximum acceleration rate of the commanded velocity input to the velocity loop. This limit is used in velocity mode only. In position mode, the trajectory generator handles acceleration limiting.
Deceleration Limit	Limits the maximum deceleration rate of the commanded velocity input to the velocity loop. This limit is used in velocity mode only. In position mode, the trajectory generator handles deceleration limiting.
Fast Stop Ramp	Specifies the deceleration rate used by the velocity loop when the amplifier is hardware disabled. (Fast stop ramp is not used when amplifier is software disabled.) If the brake output is active, the fast stop ramp is used to decelerate the motor before applying the brake. Note that Fast Stop Ramp is used only in velocity mode. In position mode, the trajectory generator handles controlled stopping of the motor. There is one exception: if a non-latched following error occurs in position mode, then the amplifier drops into velocity mode and the Fast Stop Ramp is used. For more information, see Following Error Fault Details (p. 73) .

11.5.4: Diagram: Effects of Limits on Velocity Command

The following diagram illustrates the effects of the velocity loop limits.

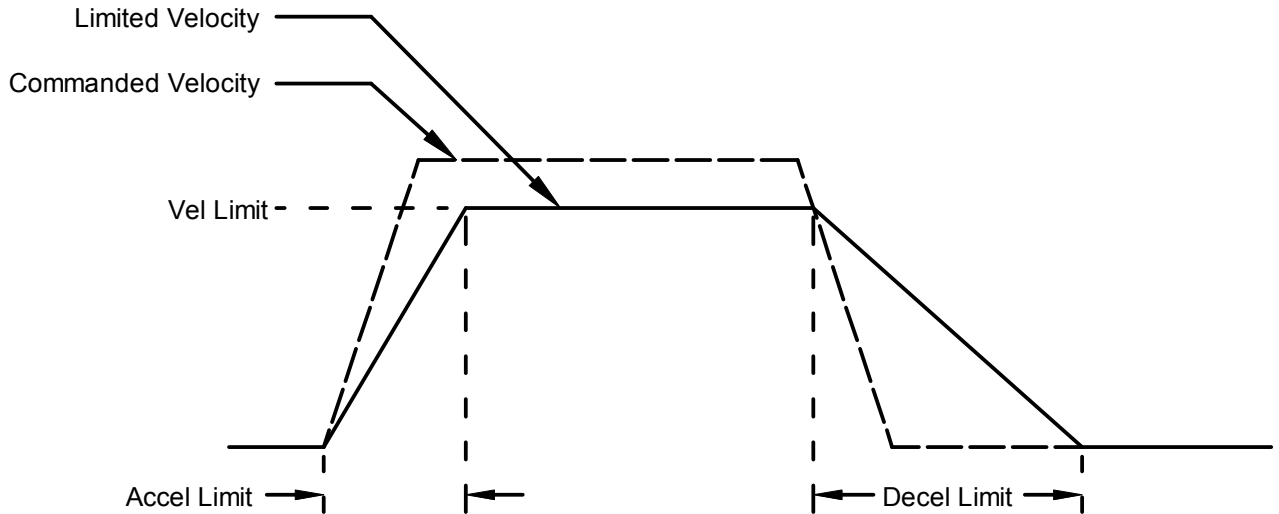

11.5.5: Velocity Loop Gains

The velocity loop uses these gains:

Gain	Description
Vp - Velocity loop proportional	The velocity error (the difference between the actual and the limited commanded velocity) is multiplied by this gain. The primary effect of this gain is to increase bandwidth (or decrease the step-response time) as the gain is increased.
Vi - Velocity loop integral	The integral of the velocity error is multiplied by this value. Integral gain reduces the velocity error to zero over time. It controls the DC accuracy of the loop, or the flatness of the top of a square wave signal. The error integral is the accumulated sum of the velocity error value over time.

11.5.6: Velocity Gains Shift

The *Velocity Gains Shift* feature adjusts the resolution of the units used to express Vp and Vi, providing more precise tuning. If the non-scaled value of Vp or Vi is 64 or less, the Low Gains Shift option is available to increase the gains adjustment resolution. (Such low values are likely to be called for when tuning a linear motor with an encoder resolution finer than a micrometer.) If the non-scaled value of Vp or Vi is 24001 or higher, the High Gains Shift option is available to decrease the gains adjustment resolution.

11.5.7: Velocity Loop Command and Output Filters

The velocity loop contains two programmable digital filters. The input filter should be used to reduce the effects of a noisy velocity command signal. The output filter can be used to reduce the excitation of any resonance in the motion system.

Two filter classes can be programmed: the Low-Pass and the Custom Bi-Quadratic. The Low-Pass filter class includes the Single-Pole and the Two-Pole Butterworth filter types. The Custom Bi-Quadratic filter allows advanced users to define their own filters incorporating two poles and two zeros.

For more information, see [Low-Pass and Bi-Quad Filters \(p.169\)](#).

11.5.8: Velocity Loop Outputs

The output of the velocity loop is a current command used as the input to the current loop.

11.6: Position Loop Setup and Tuning

Initial position loop proportional gain (Pp), velocity feed forward (Vff), and acceleration feed forward (Aff) values can be calculated with [The Calculate Function](#) (p. 46).

Enter basic Position Loop settings

1

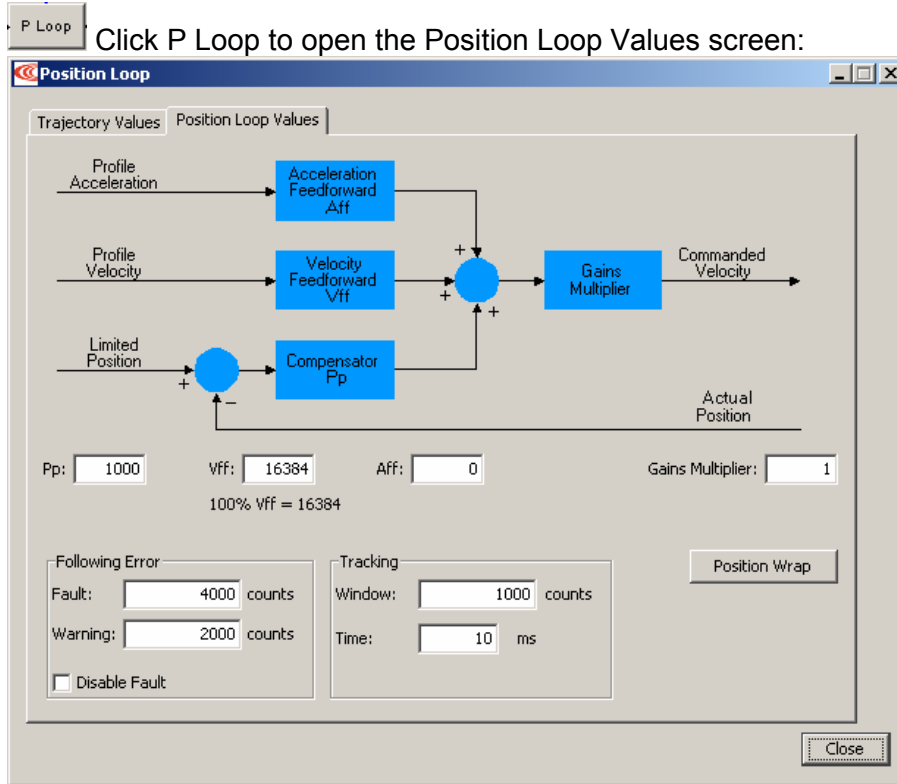

2

Change/verify Position Loop Values as needed. Click **Close** when done.

Gain	Description
Aff	Acceleration feed forward. Range: 0 to 32,767. See Trajectory Limits (p. 113).
Vff	Velocity feed forward. Range: 0 to 32,767. 100% Vff: 16,384. See Trajectory Limits (p. 113).
Pp	Position loop proportional gain. Range: 0 to 32,767. See Trajectory Limits (p. 113).
Gains Multiplier	Position loop output is multiplied by this value before going to the velocity loop. In dual encoder systems, the multiplier's initial value is calculated based on the ratio of motor encoder turns to position encoder turns. See Feedback Parameters (p. 42).
Following Error	Description
Fault	The level (in encoder counts) at which the following error produces a fault, which stops the servo loop. We recommend raising the fault level before tuning the loop. See Following Error Fault Details (p. 73).
Warning	The level (in counts) at which the following error produces a warning (without stopping the loop). See Following Error Fault Details (p. 73).
Disable Fault	Stops following error from faulting. Following Error Fault Details (p. 73).
Tracking	Description
Tracking Window	Width of tracking window in counts. See Tracking Window Details (p. 74).
Tracking Time	Position must remain in the tracking window for this amount of time to be considered tracking. See Tracking Window Details (p. 74).

3 Optionally click **Position Wrap** to open the Position Wrap screen:

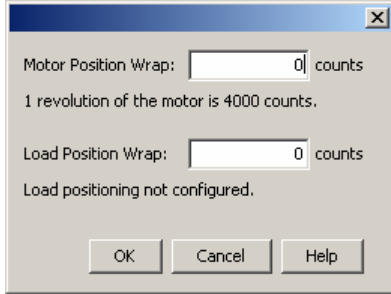

4 Change/verify the position wrap parameters as needed. Set both values to zero to disable position wrapping. Note that the changes do not take effect until **OK** is pressed. For more information about this feature, see [Position Wrap \(p. 114\)](#).

Parameter	Description
Motor Position Wrap	Position at which the actual motor position count returns to zero. In a single feedback system, it also applies to the actual load position.
Load Position Wrap	Position at which the actual load position count returns to zero in dual feedback systems. If the position encoder is set to passive mode, this value applies to the passive encoder position.

5 Click on the Trajectory Values tab:

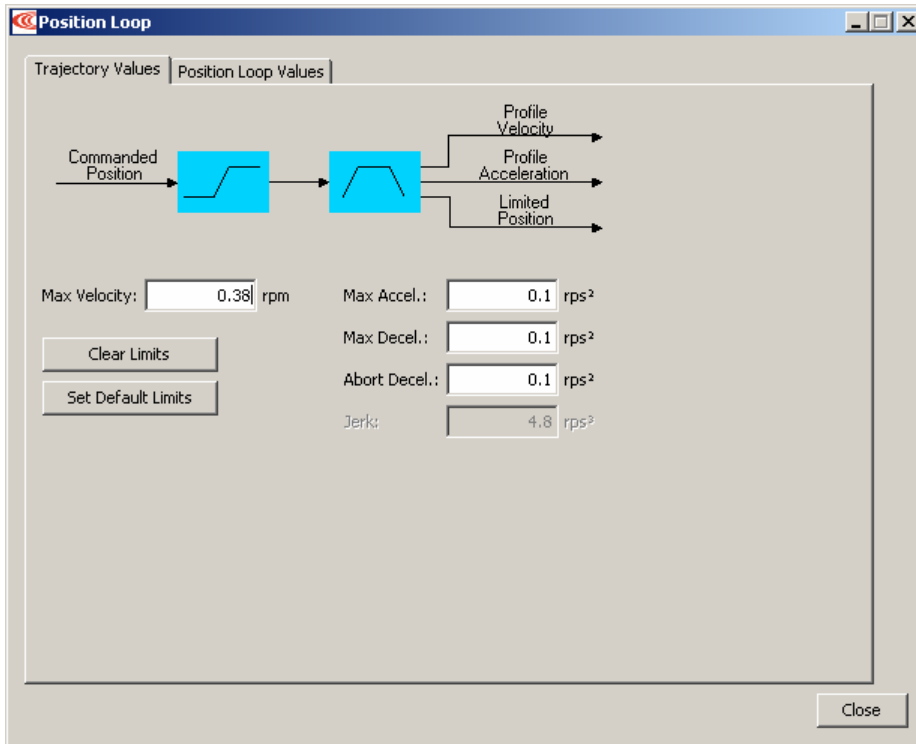

6

Change/verify the trajectory values as needed:	
Parameter	Description
Max Velocity	Maximum trajectory velocity. Max value may depend upon the back EMF and the Max feedback count. Min:0. Default: 0.25 x motor velocity limit.
Max Accel	Maximum trajectory acceleration. Max value may depend upon the load inertia and peak current. Min:0. Default: 0.5 x velocity loop <i>Accel. Limit</i> value.
Max Decel	Maximum trajectory deceleration. Max value may depend upon the load inertia and peak current. Min:0 (disables limit). Default: 0.5 x velocity loop <i>Accel. Limit</i> value.
Abort Decel	Deceleration rate used by the trajectory generator when motion is aborted. Min:0. Default: 0.5 x velocity loop <i>Accel. Limit</i> value.
Jerk	Rate of change of acceleration. The value of jerk set during the calculate procedure produces an S-Curve whose maximum slope is equal to the trajectory profile slope. This value will produce a maximum acceleration that is not more than the initial default value of acceleration. Small values will produce less jerking but will take longer to complete move. Large values will produce more jerking and a more trapezoidal profile but will complete the move faster.
	Note that setting limits to zero disables the trajectory generator so that the command input is not limited by the generator. Velocity is only limited by the Velocity Limit set in the Velocity Loop.

Manually tune the position loop

METHOD: Minimize following error and oscillation by running profiles and adjusting position proportional gain (Pp), velocity feed forward (Vff), acceleration feed forward (Aff) and other settings. For instance:

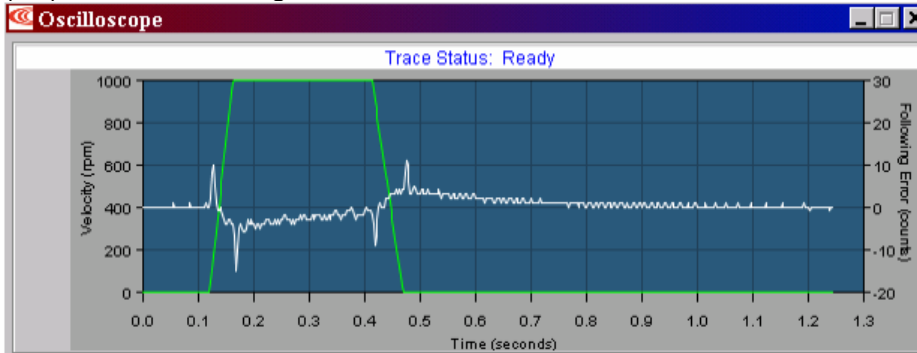

NOTE: During tuning, observe warnings that appear to the left of the trace.

1



Click the Scope Tool.

2



Select the *Profile* tab.

3

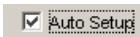

On the *Settings* tab, make sure **Auto Setup** is selected. Auto Setup automatically sets the following parameters:

Profile Tab	
Parameter	Description
Move	Relative
Type	Trap
Distance	2000 counts
Reverse and repeat	Not selected
Settings Tab	
Channel 1	Profile velocity (green)
Channel 2	Following error (white)

4



If the Auto Setup default profile distance is not appropriate, enter an appropriate short distance.

5



Click **Start**. The Profile Generator executes a short move.

NOTES:

- 1) The profile may not reach constant velocity during a short move.
- 2) If a following error occurs, open the *Control Panel* and click **Clear Faults**.

Continued...

...Continued:

6

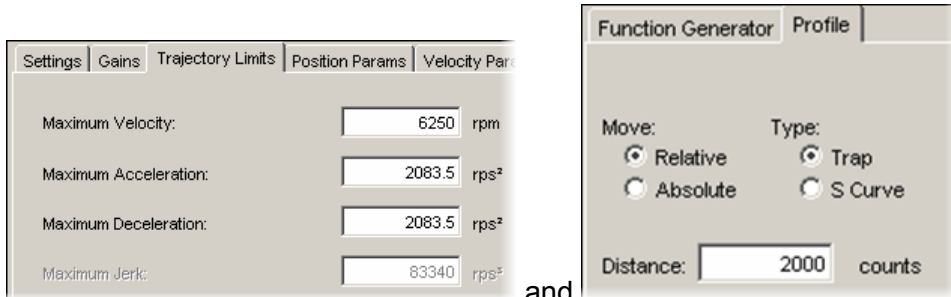

Set up a trapezoidal profile by setting the trajectory limits and distance. See table:

Trajectory Limits Tab	
Parameter	Description
Maximum Velocity	Set values typical of those expected to be used in the application.
Maximum Acceleration	
Maximum Deceleration	
Profile Tab	
Distance	Set the move distance to produce a complete trajectory profile. Be sure that this distance does not exceed mechanical limits of the system.
Move	Relative
Type	Trap

7

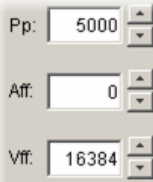

Adjust position proportional gain (Pp) to minimize following error:

- On the *Gains* tab, set velocity feed forward (Vff) and acceleration feed forward (Aff) to zero.
- On the *Profile* tab, click **Start**. On the *Gains* tab, adjust position loop proportional gain (Pp) until best result is obtained.
- Click **Start** after each adjustment to test on a new profile move.

NOTES:

- 1) Too much position loop proportional gain (Pp) might cause oscillation.
- 2) If a following error occurs, open the *Control Panel* and click **Clear Faults**.

8

Adjust velocity feed forward (Vff):

- Velocity feed forward (Vff) reduces following error in the constant velocity portion of the profile. Often, a velocity feed forward (Vff) value of 16384 (100%) provides best results.
- Click in the *Vff* field and adjust the value.
- Click **Start** after each adjustment to test on a new profile move.

Continued...

...Continued:

- 9** Adjust acceleration feed forward (Aff):
- Acceleration feed forward (Aff) reduces following error during profile acceleration and deceleration.
 - Click in the *Aff* field and adjust the value.
 - Click **Start** after each adjustment to test on a new profile move.

NOTES:

1) If, after tuning the position loop, the motor makes a low frequency audible noise while enabled but not moving, the velocity loop gains (V_p and V_i) may be lowered to reduce the noise. If the gain values are set too low, the response to instantaneous rates of change might be reduced (i.e., slow correction to disturbances or transients).

2) If the amplifier is set up to run in position mode under analog input command, and the analog command signal produces too much noise at the motor after tuning, the Analog Command Filter or the Velocity Loop Command Filter may be used to reduce the noise further.

See [Low-Pass and Bi-Quad Filters \(p. 169\)](#).

- 10** Tune to multiple sets of profiles representing typical moves that might be executed in the application. Starting with [Step 6 \(p. 110\)](#), repeat the process as needed.
-

Test S-Curve Profile

DISCUSSION: If the amplifier will perform S-Curve profile moves, use this procedure to tune the level of jerk. (Jerk is the rate of change of acceleration. S-Curve moves reduce jerk to provide a smooth profile.) Run an S-Curve profile and adjust velocity, acceleration, deceleration, and jerk levels until the desired profile is obtained. For instance:

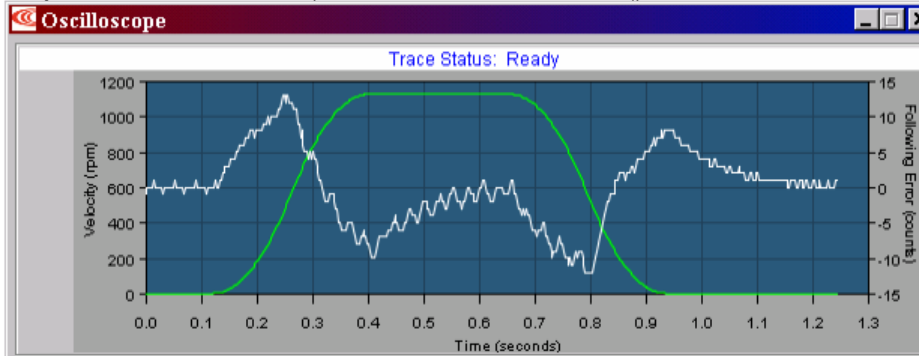

1

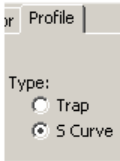

On the *Profile* tab, click the **S-Curve** button.

2

Set up an S Curve profile by adjusting the following parameters to represent a typical move under normal operation.

Trajectory Limits Tab	
Parameter	Description
Maximum Velocity	Maximum speed of the profile.
Maximum Acceleration/Deceleration	Maximum acceleration/deceleration of the profile. The deceleration is set to be the same as acceleration.
Maximum Jerk	The value of jerk set during the calculate procedure produces an S-Curve whose maximum slope is equal to the trajectory profile slope. This value will produce a maximum acceleration that is not more than the initial default value of acceleration. Small values will produce less jerking but will take longer to complete move. Large values will produce more jerking and a more trapezoidal profile but will complete the move faster.
Profile Tab	
Distance	Increase the move distance to produce a complete trajectory profile. Use an acceptable value the does not exceed mechanical limits of the system.
Move	Relative
Type	S-Curve

3

Click **Start**.

4

Try multiple sets of profiles representing typical moves that might be executed in the application. Starting with [Set up an S Curve profile](#), repeat the process as needed.

11.7: Notes on the Position Mode and Position Loop

11.7.1: Position Loop Diagram

The amplifier receives position commands from the digital or analog command inputs, over the CAN interface or serial bus, or from the CVM Control Program. When using digital or analog inputs, the amplifier's internal trajectory generator calculates a trapezoidal motion profile based on trajectory limit parameters. When using the CAN bus, serial bus, or CVM Control Program, a trapezoidal or S-curve profile can be programmed. The trajectory generator updates the calculated profile in real time as position commands are received.

The output of the generator is an instantaneous position command (limited position). In addition, values for the instantaneous profile velocity and acceleration are generated. These signals, along with the actual position feedback, are processed by the position loop to generate a velocity command.

To bypass the trajectory generator while in digital or analog position modes, set the maximum acceleration to zero. The only limits in effect will now be the velocity loop velocity limit and the current limits. (Note that leaving the maximum acceleration set to zero will prevent other position modes from operating correctly.)

The following diagram summarizes the position loop.

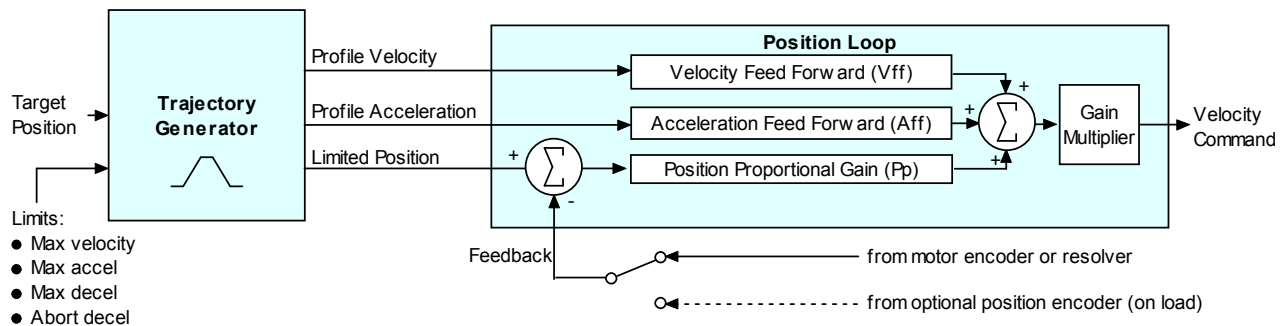

11.7.2: Trajectory Limits

In position mode, the trajectory generator applies these limits to generate the profile.

Limiter	Description
Maximum Velocity	Limits the maximum speed of the profile.
Maximum Acceleration	Limits the maximum acceleration rate of the profile.
Maximum Deceleration	Limits the maximum deceleration rate of the profile.
Abort Deceleration	Specifies the deceleration rate used by the trajectory generator when motion is aborted.

11.7.3: Position Loop Inputs From the Trajectory Generator

The position loop receives the following inputs from the trajectory generator.

Input	Description
Profile Velocity	The instantaneous velocity value of the profile. Used to calculate the velocity feed forward value.
Profile Acceleration	The instantaneous acceleration/deceleration value of the profile. Used to calculate the acceleration feed forward value.
Limited Position	The instantaneous commanded position of the profile. Used with the actual position feedback to generate a position error.

11.7.4: Position Loop Gains

The following gains are used by the position loop to calculate the velocity command:

Gain	Description
Pp - Position loop proportional	The loop calculates the position error as the difference between the actual and limited position values. This error in turn is multiplied by the proportional gain value. The primary effect of this gain is to reduce the following error.
Vff - Velocity feed forward	The value of the profile velocity is multiplied by this value. The primary effect of this gain is to decrease following error during constant velocity.
Aff - Acceleration feed forward	The value of the profile acceleration is multiplied by this value. The primary effect of this gain is to decrease following error during acceleration and deceleration.
Gain Multiplier	The output of the position loop is multiplied by this value before being passed to the velocity loop.

11.7.5: Position Loop Feedback

Some Copley Controls amplifiers feature dual-sensor position loop feedback, configured as follows:

- Single sensor. Position loop feedback comes from the encoder or resolver on the motor.
- Dual sensor. Position loop feedback comes from the encoder attached to the load.

(Note that in either case, velocity loop feedback comes from the motor encoder or resolver.) For more information, see [Feedback Notes \(p 44\)](#).

Position Loop Output

The output of the position loop is a velocity command used as the input to the velocity loop.

11.7.6: Position Wrap

The position wrap feature causes the position reported by the amplifier to “wrap” back to zero at a user-defined value instead of continually increasing. Once set, the reported position will be between 0 and n-1 where n is the user entered wrap value. This feature is most useful for rotary loads that continually turn in one direction and only the position within a revolution is of interest to the user.

Relative moves with the wrap value set will move the relative distance called for. Example; if the wrap value is set to 1000 and a relative move of 2500 is commanded, the axis will turn 2 ½ revolutions.

Absolute moves will move the shortest distance to arrive at the programmed position. This could be in the positive or negative direction. Moves programmed to a point greater than the wrap value will cause an error.

To configure the position wrap feature, see [Enter basic Position Loop settings \(p. 106\)](#).

11.8: Auto Tune all Loops for Linear Motors

The Auto Tune all loops feature is available for use with linear motors.



Make sure motor is mounted firmly and verify accuracy and completeness of motor data.

Failure to heed this warning can cause equipment damage, injury, or death.

DANGER

Tune All Loops with Auto Tune (Linear Motors)

At any point, use **Back** to return to the previous screen. Use **Skip** to tune the velocity loop without tuning the current loop, or to tune the position loop without tuning the velocity loop.

- 1 Verify the motor is mounted firmly. Also verify the accuracy and completeness of the motor settings. See [Motor/Feedback \(p. 37\)](#).

Current Loop

- 2 Make sure the amplifier's [Basic Setup \(p. 29\)](#) and [Motor Phasing \(p. 75\)](#) procedures have been performed, and that the system is capable of a 10 mm move.

3



Click **Auto Tune** to open the Current Loop Tune screen.

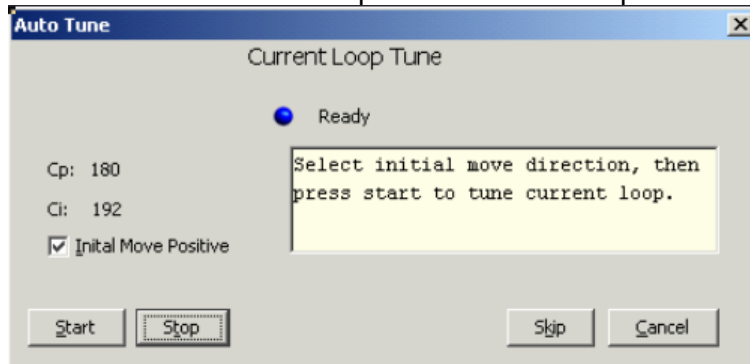

The status indicator is blue when the amplifier is ready for tuning.

- 4 Verify the Initial Move Positive setting. In most cases, this option should be set. If positive initial motion is not possible, you can specify negative initial motion by clearing this option. For instance, negative initial motion may be used when a vertical axis is at the bottom of the motion range and the positive direction is down.

Continued...

...Continued:

- 5** Click **Start** to tune the current loop. During tuning, the status indicator is amber. Cp and Ci values change as the text in the status box gives progress updates. When the current loop has been tuned, the status indicator turns green, and the status box contains instructions for the next step.

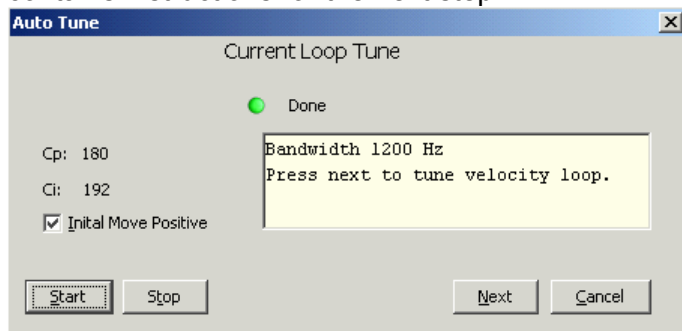

Velocity Loop:

- 6** Click **Next** to open the Jog screen.

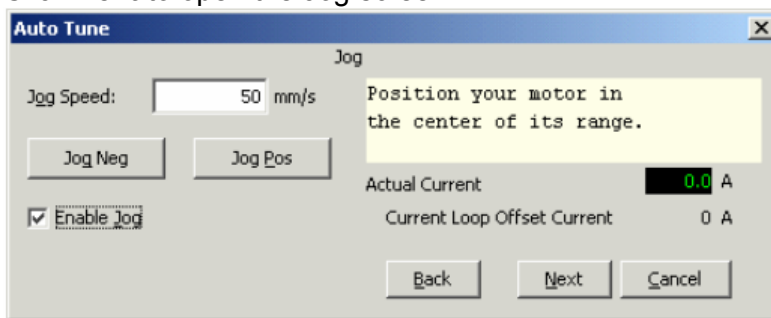

- 7** Move the motor to the center of its motion range. To use a jog move:
- Set the Enable Jog option.
 - Optionally adjust the jog speed
 - Jog the motor in either direction to move it to the center of its motion range.

Continued...

...Continued:

- 8 When the motor is centered, click **Next**.
If the amplifier must apply current to hold the new position against a force (such as gravity in a vertical application), the following message appears:

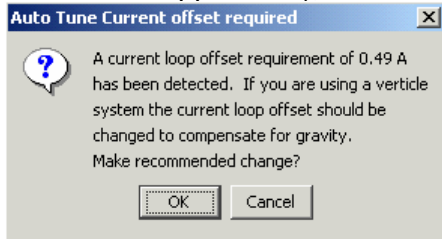

If this message appears, click **OK**.
The Velocity Loop Tune screen opens:

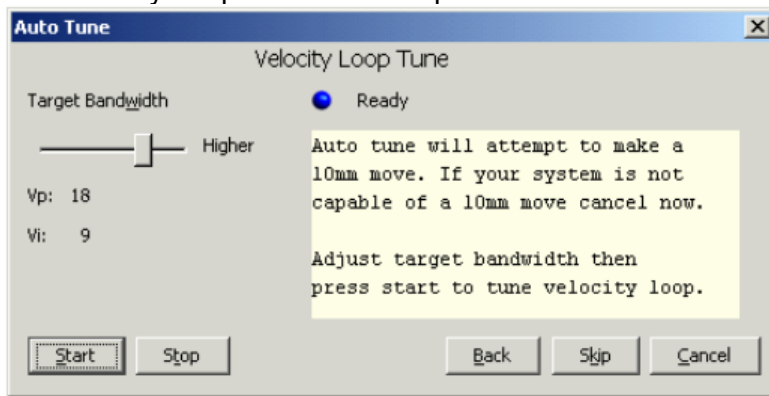

- 9 Optionally adjust the Target Bandwidth.
TIP: Increase bandwidth for more stiffness in the holding position. Decrease bandwidth to eliminate buzzing or oscillations caused when the load is removed.

Continued...

...Tune All Loops with Auto Tune, Velocity Loop, continued:

- 10 Click **Start** to tune the velocity loop. During tuning, the status indicator is amber. Vp and Vi values change as the text in the status box gives progress updates. When the velocity loop has been tuned, the status indicator turns green, and the status box contains instructions for the next step:

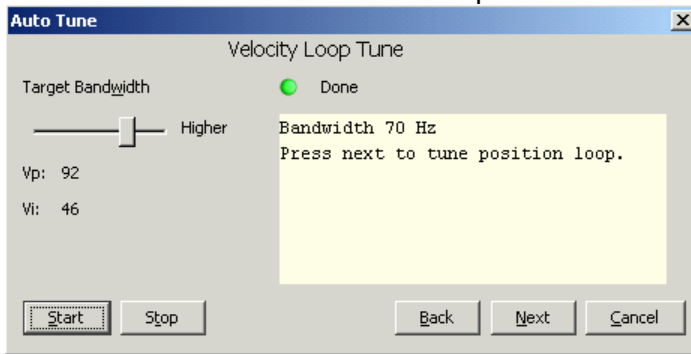

Position Loop:

- 11 Click **Next** to open the Position Loop Tune screen:

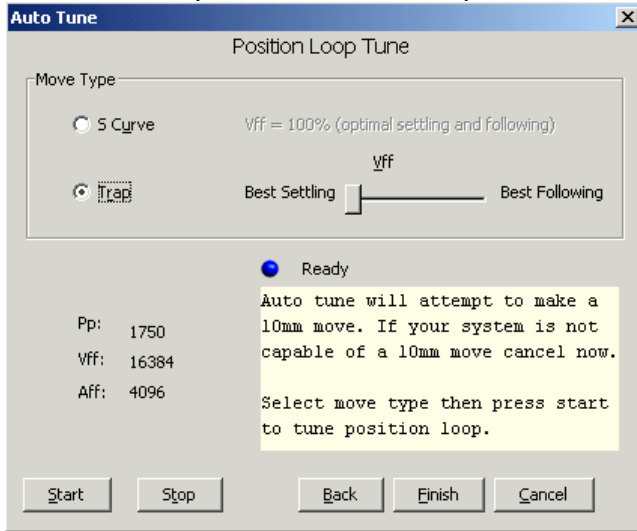

- 12 Verify the Move Type setting (S-Curve or Trap).
- 13 For a trapezoidal profile, optionally optimize the tuning along the scale between Best Settling (for quicker settling) and Best Following (for less following error).

Continued...

...Tune All Loops with Auto Tune, Position Loop, continued:

- 14 Click **Start** to tune the position loop. During tuning, the status indicator is amber. Pp, Vff, and Aff values change as the text in the status box gives progress updates. When the position loop has been tuned, the status indicator turns green, and the status box contains instructions for the next step:

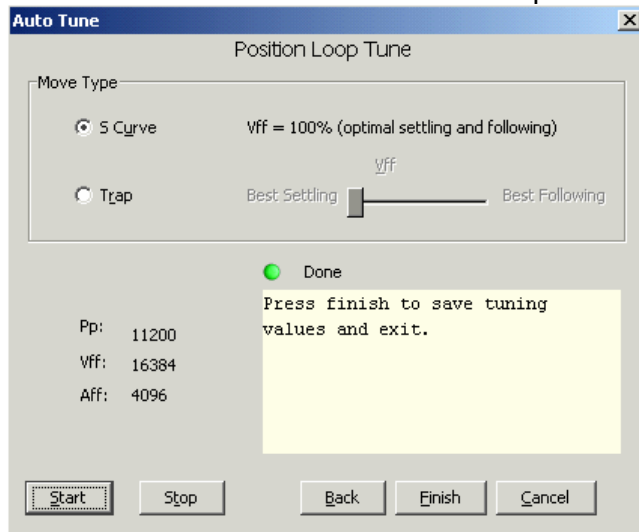

- 15 Click **Finish**. See the reminder:

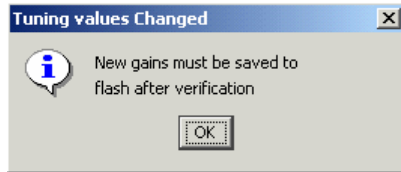



- 16 Click **OK**.

- 17  On the CME 2 *Main* screen, click **Save to Flash**.

CHAPTER

12: STEPPER CONTROLS

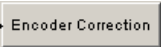
This chapter describes set up and tuning steps that are particular to stepper amplifiers. The basic operations are listed below. Details follow in the chapter.

- ✓  [Set Position Limits in Stepper Mode \(p. 123\).](#)
 - ✓  [Set Encoder Correction Gain \(p. 125\).](#)
 - ✓  [Tune Stepper Detent Gain \(p. 126\).](#)
-

12.1: Stepper Motor Support

CME 2 supports Copley's stepper amplifier family. Stepper amplifiers can run in stepper mode or servo mode.

This chapter describes controls that can be used to fine-tune a stepper amplifier in stepper mode: [Encoder Correction \(p. 125\)](#) and [Detent Compensation Gain \(p. 126\)](#). It also describes the screen used in stepper mode to set [Position Limits \(p. 123\)](#).

When a stepper amplifier is used in servo mode, it operates as a true, closed loop, servo amplifier controlling a stepper motor. After putting the stepper amplifier into servo mode, set it up and tune it just as you would a servo amplifier.

12.2: Position Limits (Stepper Amplifier)

Perform the following steps to set position limits for a stepper amplifier connected to an encoder with Encoder Correction enabled (not operating in Servo mode).

Set Position Limits in Stepper Mode

- 1  Click to open the stepper *Position Limits* screen. Click the *Trajectory Values* tab.

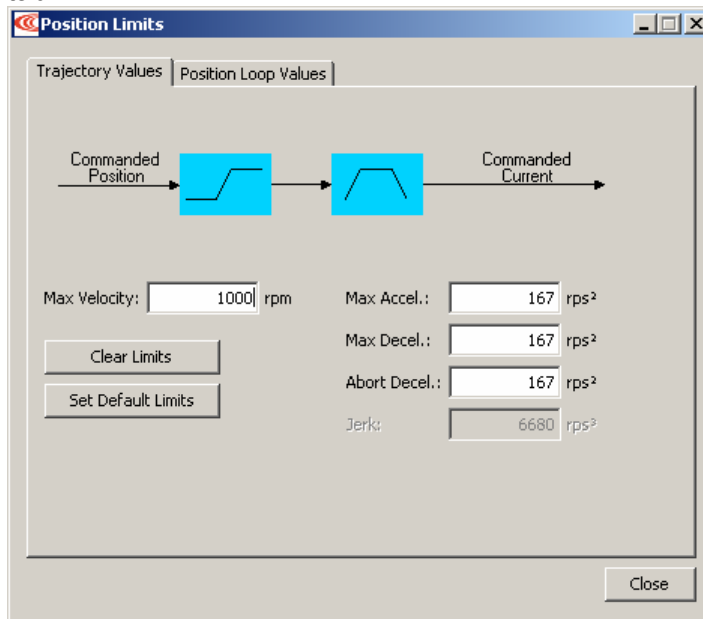

- 2 Change/verify the values as needed:

Max Velocity	Maximum trajectory velocity. Max value may depend upon the back EMF and the Max feedback count. Min:0. Default: 0.25 x motor velocity limit.
Max Accel	Maximum trajectory acceleration. Max value may depend upon the load inertia and peak current. Min:0. Default: 0.5 x velocity loop <i>Accel. Limit</i> value.
Max Decel	Maximum trajectory deceleration. Max value may depend upon the load inertia and peak current. Min:0 (disables limit). Default: 0.5 x velocity loop <i>Accel. Limit</i> value.
Abort Decel	Deceleration rate used by the trajectory generator when motion is aborted. Min:0. Default: 0.5 x velocity loop <i>Accel. Limit</i> value.
	Note that setting limits to zero disables the trajectory generator so that the command input is not limited by the generator. Velocity is only limited by the Velocity Limit set in the Velocity Loop.

3 Click the *Position Loop Values* tab:

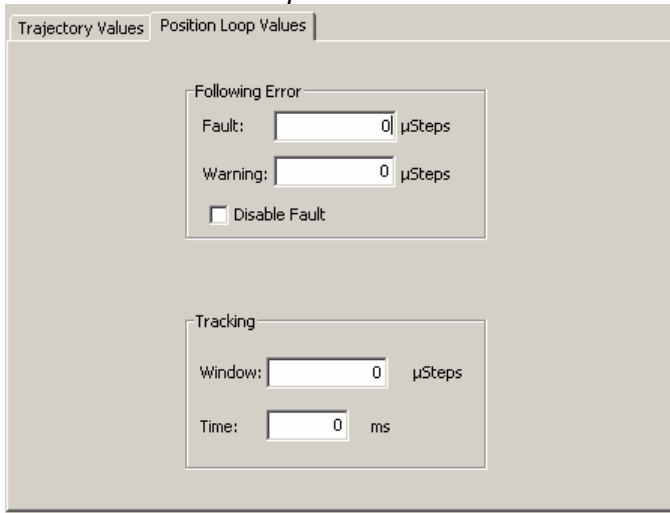

4 Change/verify the values as needed:

Limit	Description
Following Error	
Fault	The level (in encoder counts) at which the following error produces a fault, which stops the servo loop. We recommend raising the fault level before tuning the loop. See Following Error Fault Details (p. 73) .
Warning	The level (in counts) at which the following error produces a warning (without stopping the loop). See Following Error Fault Details (p. 73) .
Disable Fault	Stops following error from faulting. Following Error Fault Details (p. 73) .
Tracking	
Window	Width of tracking window in counts. See Tracking Window Details (p. 74) .
Time	Position must remain in the tracking window for this amount of time to be considered tracking. See Tracking Window Details (p. 74) .

5 Click **Close** to close the window.

6  On the CME 2 *Main* screen, click **Save to Flash**.

12.3: Encoder Correction

For a stepper motor with an encoder, Encoder Correction proportional gain can be used to compensate for lost microsteps.

Set Encoder Correction Gain

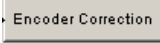
- 1  Click to open the *Encoder Correction* screen.

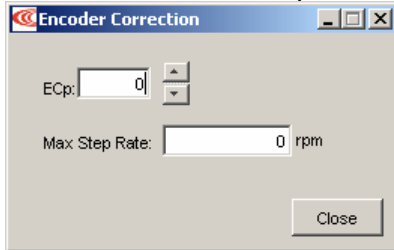

- 2 Set the Encoder Correction parameters:

Parameter	Description
ECp	Proportional gain used to compensate for lost microsteps. Default: 0.
Max Step Rate	Maximum velocity allowed while using ECp to correct position errors. Excessive velocity can result in more lost microsteps. Default: 0.

12.4: Detent Compensation Gain

Stepper motors are subject to torque detent that can cause undesired velocity fluctuation between full steps of motion. The Detent gain feature can compensate for this detent.

Tune Stepper Detent Gain

- 1 Click **Detent** to open the stepper amplifier *Advanced Tuning* screen.

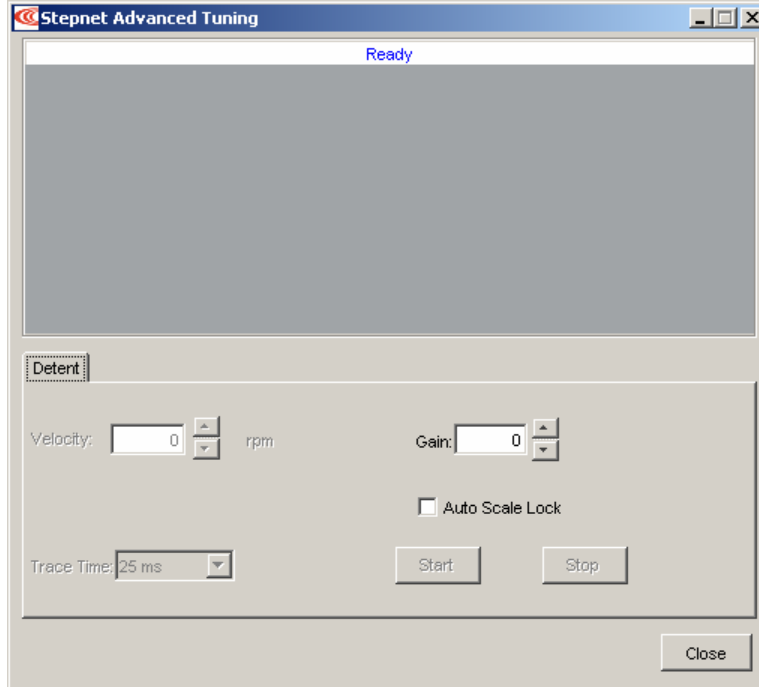

Screen settings and controls are described below:

Setting	Description
Velocity	Tuning velocity. Default: 0.
Trace Time	Length of trace interval to be shown on screen. Default: 25 ms.
Gain (Detent Gain)	The Stepper Detent Gain value. Default: 0.
Auto Scale Lock	When selected, prevents trace display from rescaling during tuning.

- 2 Click **Start** to begin the tuning.
- 3 Adjust **Velocity** from 0 until the mechanical system begins to resonate. (Using a 1.8 degree step motor with 200 full steps, this will typically occur at a velocity of 40-70 rpm.)
- 4 Adjust **Gain** until the resonance increases, and then back it down until the resonance is minimized.
- 5 Click **Stop** to stop the tuning.
- 6 Click **Close** to close the window.
- 7  On the CME 2 *Main* screen, click **Save to Flash**.

CHAPTER

13: HOMING

Set homing parameters and run optional homing tests. Perform the steps outlined below.

- 1 On *Main* screen, click **Home** to open the *Homing* screen.

- 2 Select the following homing parameters:

Parameter	Description
Software limits: Positive	Position of user-defined travel limits that take effect after homing operation.
Software limits: Negative	
Software limits: Deceleration Rate	Deceleration rate used to stop a motor when approaching a software limit.
Software limits: Disable	Disables the use of software limits by setting both limits to zero.
Method	Homing method. See Homing Methods (p. 171) .
Direction of Motion	Initial direction of motion for the homing method (Pos or Neg).
Fast Velocity	The velocity used to find a limit or home switch. Also used when moving to an offset position, or a resolver or Servo Tube index position.
Slow Velocity	The velocity used to find a switch edge, incremental or analog encoder index pulse, or hard stop.
Accel/Decel	The acceleration and deceleration rate used during homing.
Offset	Execute a move of this distance after the reference is found. Set actual position to 0 and call the new position home.
Current Limit	Hard stop home is reached when the amplifier outputs the homing Current Limit continuously for the time specified in the Delay Time.
Current Delay Time	
Following Warning	Shows the programmed following warning level.
Actual Current	Shows actual current being applied to windings during homing.
Actual Position	Shows the actual position of the axis.

- 3 Optionally click **Home** to begin a homing sequence. To stop immediately, click **Stop**.
- 4 Click **Save** to save the settings to flash memory. Click **Exit** to close the screen.

CHAPTER

14: CONTROL PANEL

Become familiar with the CME 2 Control Panel and its functions. Perform the steps outlined below to access the panel and its functions. Details follow in chapter.

1

 Click to open the *Control Panel*:

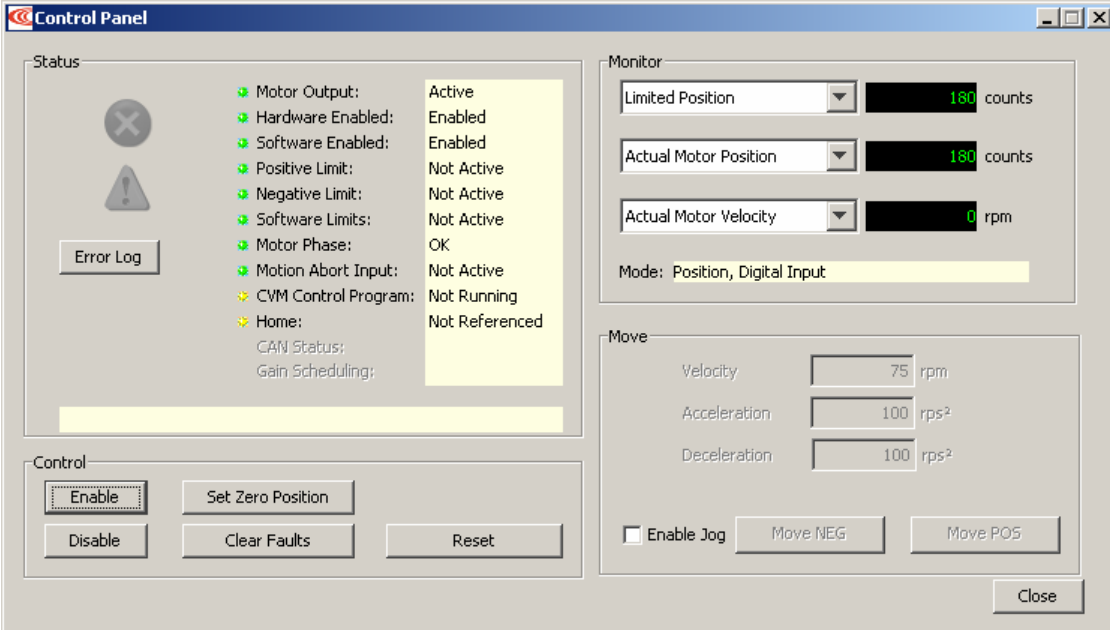

2

See this chapter for a [Control Panel Overview](#) (p. 130) and details on:

- [Status Indicators and Messages](#) (p. 130)
- [Control Panel Monitor Channels](#) (p. 131)
- [Control Functions](#) (p. 132)
- [Jog Mode](#) (p. 133)

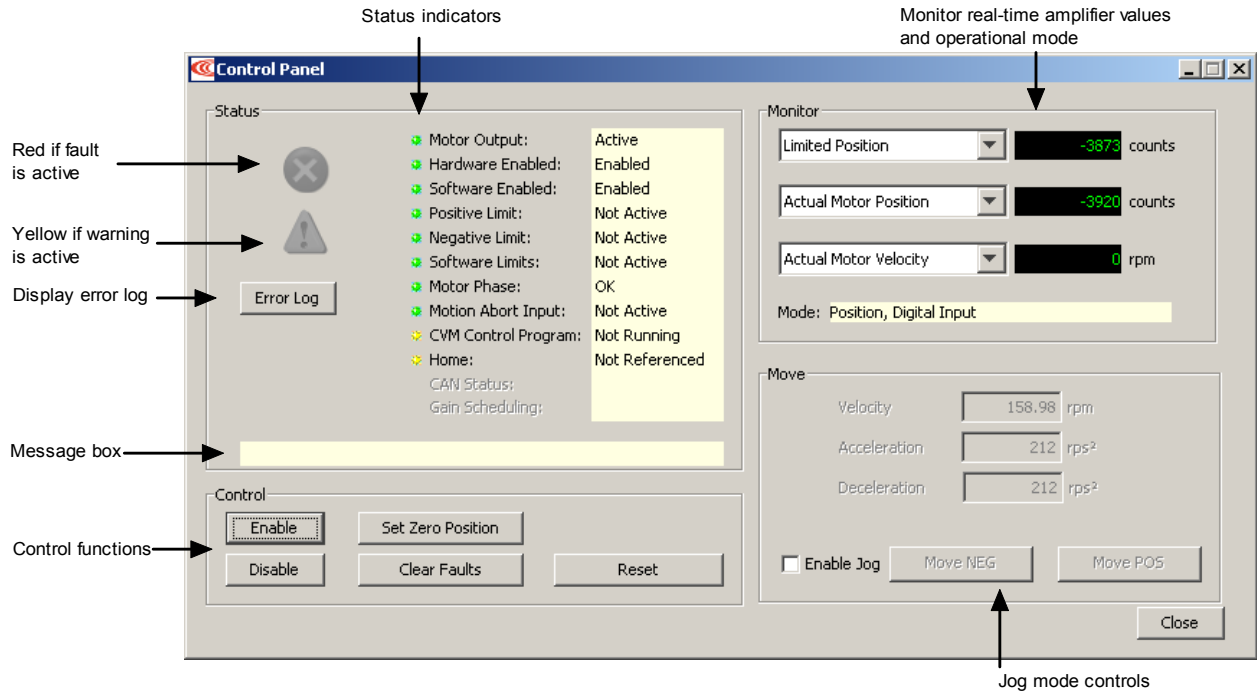

14.1: Control Panel Overview

Each of the Control Panel features labeled below is described in the following sections.



14.2: Status Indicators and Messages

The *Status* area includes status indicator lights (described below) and a message box. Any red lights indicate that motion will be inhibited.

Indicator	States/Description
Motor Output	State of the PWM output stage. Red if the output stage is inactive (disabled)
Hardware Enabled	State of the hardware enable input(s). Red if one or more enable inputs are inactive.
Software Enabled	State of the software enable. Red if the amplifier is disabled by software.
Positive Limit	State of the positive limit switch input. Red indicates an activated positive limit switch.
Negative Limit	State of the negative limit switch input. Red indicates an activated negative limit switch.
Software Limits	State of the software limits. Red indicates an activated software limit.
Motor Phase	Indicates a motor phasing error. Red indicates a motor phasing error exists.
Motion Abort Input	State of the programmed Motion Abort Input. Red indicates the input is active.
CVM Control Program	Status of the CVM Control Program.
Home	Indicates whether the axis has successfully been referenced (homed).
CAN Status	Status of the CAN Bus. Yellow indicates CAN warning limit reached. Red indicates bus error detected. (For DeviceNet, see the <i>Copley DeviceNet Programmer's Guide</i> .)
Gain Scheduling	Indicates whether Gain Scheduling (p. 193) is active.
	The fault indicator goes red when a fault is active. Check the status message box for a description of the most recent fault: <code>Fault: Under Voltage</code> . Check the Error Log for a full history of faults and warnings.
	The warning indicator goes yellow when a warning is active. Check the status message box for a description of the most recent: <code>Warning: Pos Outside of Tracking Window</code> . Check the Error Log for a full history of faults and warnings.
Message Box	Displays status descriptions.

14.3: Control Panel Monitor Channels

The Control Panel Monitor channels can display real-time values on up to three separate variables. The procedure follows.

Set up a monitor display channel

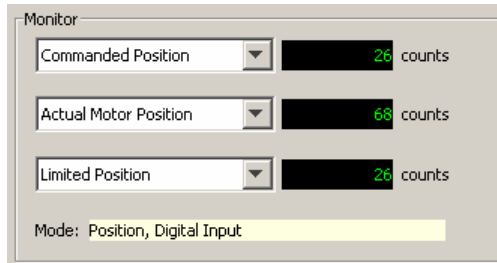

Click in the list box and select a variable from the list. **Disabled** disables the display. Other options represent the following amplifier values:

- Actual Current
- Actual Motor Velocity
- Actual Motor Position
- Actual Load Velocity
- Actual Load Position
- Velocity Error
- Following Error
- Commanded Current
- Commanded Velocity
- Commanded Position
- Profile Velocity
- Profile Acceleration
- Passive Load Position
- Limited Position
- Analog Command
- Bus Voltage
- Amplifier Temperature
- Motor Phase Angle

Mode: Displays the amplifier's present operating mode. In camming it also displays the active cam table number.

14.4: Control Functions

The *Control* area of the screen provides functions related to overall amplifier control. The screen options vary with model and configuration.

Use the Control Panel Control Functions

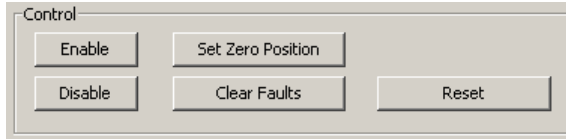

Control the operational state of the amplifier using the buttons as described below.

Control	Description
Enable	Click to software enable the amplifier.
Disable	Click to software disable the amplifier. This will also stop any CVM programs that are running.
Set Zero Position	Click to set the amplifier's actual position counter to zero.
Clear Faults	Click to clear all amplifier faults.
Reset	Click to reset the amplifier.



WARNING

Risk of unexpected or uncontrolled motion.

Using the CME 2 *Set Zero Position* function while the amplifier is operating under external control could cause unexpected or uncontrolled motion.

Failure to heed this warning can cause equipment damage.

14.5: Jog Mode

Jog mode provides a simple means for generating forward or reverse commands, as shown in the procedure below.

Run a move in jog mode

- 1 To put the amplifier in jog mode, set the **Enable Jog** option.
- 2 Set up a jog move by setting the following mode-specific parameters:

Mode	Parameter	Description
Current	Current	Current applied to the motor. Limited by current loop <i>Continuous Current</i> . Warning: Unloaded motors may, depending on torque setting, ramp up in speed very quickly.
Velocity	Jog Speed	Velocity of the jog move. Limited by velocity loop <i>Vel. Limit</i> .
Position	Velocity	Velocity of the jog move. Limited by velocity loop <i>Vel. Limit</i> .
	Acceleration	Acceleration limit of the jog move.
	Deceleration	Deceleration limit of the jog move.

- 3 Command the move:

Mode	Steps
Current	<ul style="list-style-type: none"> • Hold Pos to apply positive current to the motor or hold down Neg to apply negative current to the motor. • Release the button to command zero current.
Velocity	<ul style="list-style-type: none"> • Hold Jog Pos to command a forward velocity or hold down Jog Neg to command a negative velocity. • Release the button to command zero velocity.
Position	<ul style="list-style-type: none"> • Hold Move Pos to generate a forward move profile or hold Move Neg to generate a negative move profile. • Release the button to stop movement. <p>NOTE: Position mode jog is accomplished by continuously updating the commanded position. If a following error develops with Following Error Fault disabled, motion will not stop on button release. Instead, it stops when actual position = commanded position.</p>

CHAPTER

15: SCOPE TOOL

This chapter shows how to use the CME 2 Scope Tool to program and test motion sequences. Perform the steps outlined below to access the Scope Tool. Details follow in the chapter.

1



Click to open the *Scope Tool*:

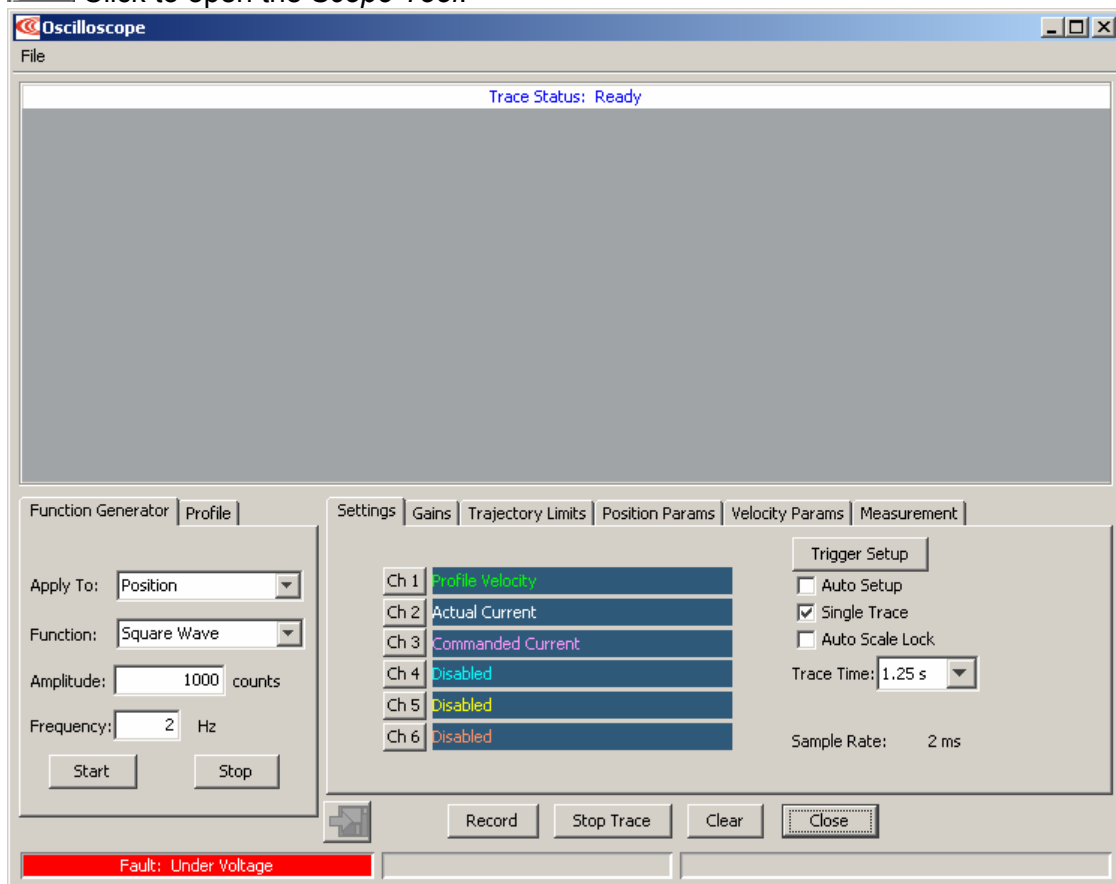

2

See this chapter for a [Scope Tool Overview \(p. 136\)](#) and details on:

- [Function Generator and Profile Tabs \(p. 137\)](#)
- [Trace Channel Variable Parameters \(p. 138\)](#)
- [Trigger Setup \(p. 139\)](#)
- [Trace Time, Sample Rate and Single Trace \(p. 140\)](#)
- [Scope Display Parameters \(p. 140\)](#)
- [Auto Setup \(p. 141\)](#)
- [Measurement Tab \(p. 142\)](#)
- [Control Loop Parameters \(p. 143\)](#)

15.1: Scope Tool Overview

The *Scope Tool* can be used to tune the amplifier, monitor performance, and perform diagnostics. *Function Generator* and *Profile Generator* can drive the motor without external control. *Auto Set Up* feature sets typical initial values for scope parameters.

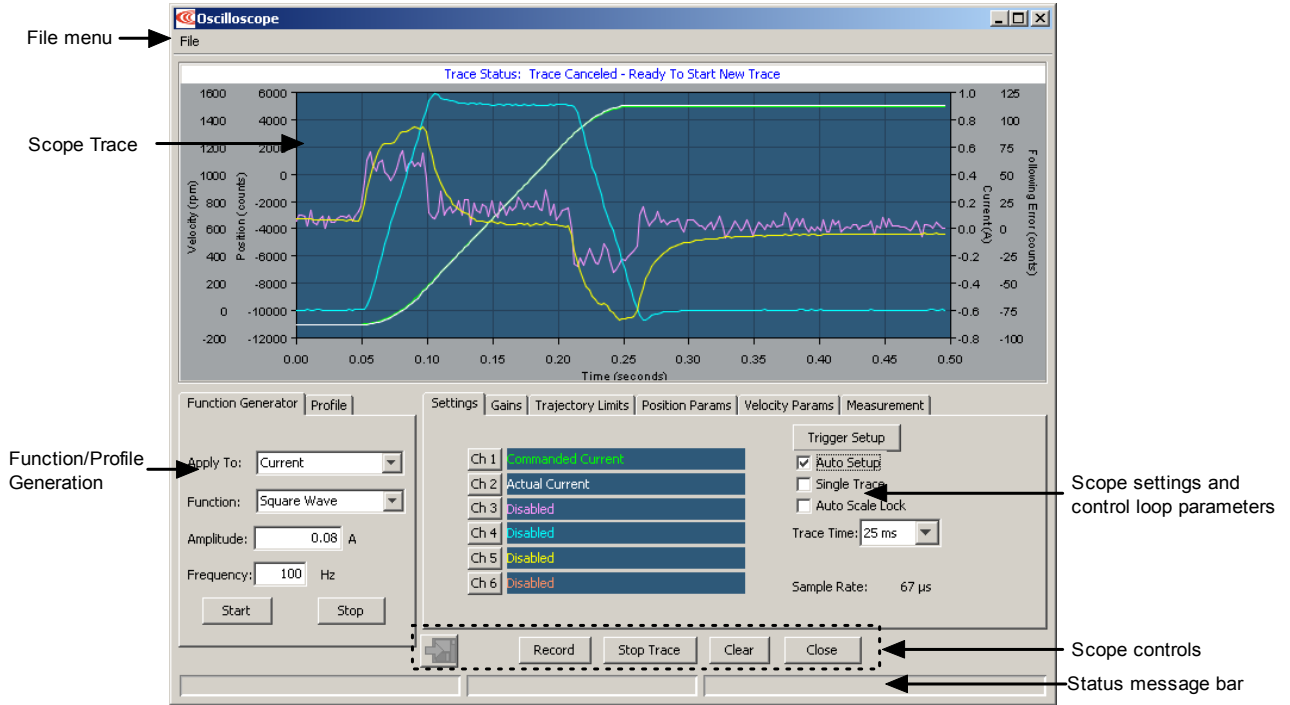

Button	Description
	Save a trace. See Scope Trace Files (p. 146) .
Record	Begins recording a trace.
Stop Trace	Stops recording a trace.
Clear	Clears the trace from the screen and trace data from buffer.
Close	Closes the scope tool.

Run a move with the Function Generator or Profile Tool

- 1 Click on the *Function Generator* or *Profile* tab.
- 2 Adjust *Function Generator* or *Profile* settings, scope tool settings, gains, limits, and parameters (as described later in this chapter).
- 3 Click **Start** to begin move and trace. Click **Stop** to stop the move.

Monitor externally controlled motion

- 1 As required, adjust scope tool settings.
- 2 Click **Record** to begin trace.
- 3 Begin move with external controller. Click **Stop Trace** to stop the trace recording.

15.2: Function Generator and Profile Tabs

The *Function* and *Profile* generators can provide inputs to the different control loops for tuning and diagnostics purposes without using an external control source.

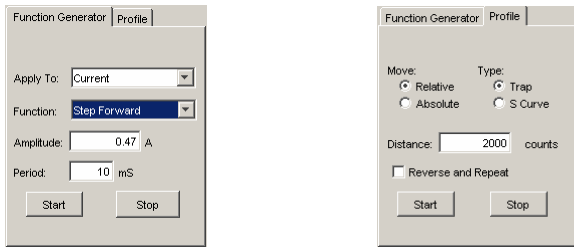

The **Start** button starts the function or profile generator. The **Stop** button stops the generator and aborts any profiles in progress.

15.2.1: Function Generator Tab

Parameter	Description								
Apply To	Control loop to which the <i>Excitation</i> will be applied: Current (available in all modes), Velocity (available in velocity or position mode), or Position (available in position mode only).								
Function	Function that will be applied to the control loop selected in the <i>Apply To</i> list box. The choices vary with the control loop selected: <table border="1" style="margin-left: 20px;"> <thead> <tr> <th>Selected Control Loop</th> <th>Functions Available</th> </tr> </thead> <tbody> <tr> <td>Current</td> <td>Sine Wave, Square Wave, Step Forward, Step Forward and Reverse, and Impulse</td> </tr> <tr> <td>Velocity</td> <td>Sine Wave, Square Wave, Step Forward, Step Forward and Reverse</td> </tr> <tr> <td>Position</td> <td>Sine Wave, Square Wave</td> </tr> </tbody> </table>	Selected Control Loop	Functions Available	Current	Sine Wave, Square Wave, Step Forward, Step Forward and Reverse, and Impulse	Velocity	Sine Wave, Square Wave, Step Forward, Step Forward and Reverse	Position	Sine Wave, Square Wave
Selected Control Loop	Functions Available								
Current	Sine Wave, Square Wave, Step Forward, Step Forward and Reverse, and Impulse								
Velocity	Sine Wave, Square Wave, Step Forward, Step Forward and Reverse								
Position	Sine Wave, Square Wave								
Amplitude	Amplitude of the command. Units vary depending on the value chosen in the <i>Apply To</i> field.								
Frequency	(Sine Wave and Square Wave only.) Frequency of input command cycle.								
Period	(Step Forward, Step Forward and Reverse, and Impulse only.) Duration of each input pulse.								

15.2.2: Profile Tab

Parameter	Description
Move	Relative: Moves axis a specified distance from the starting position. Absolute: Moves axis to a specific position.
Type	Trap or S-Curve.
Distance	Distance for <i>Relative</i> move.
Position	Target position for <i>Absolute</i> move.
Reverse and Repeat	(<i>Relative</i> move only.) When selected, will continuously generate forward and reverse moves of the distance specified until Stop is pressed.

15.3: Trace Channel Variable Parameters

Choose a trace variable for display in a Scope channel

1

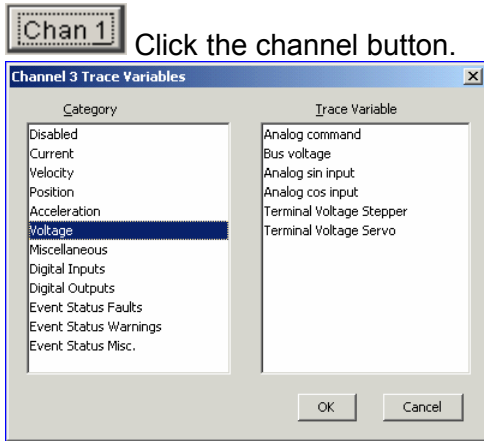

2

Choose a category and a trace variable.

Category	Trace Variable
Disabled	<Channel disabled, no associated variable>
Current	Commanded Current, Actual Current, Limited Current, I ² T Amplifier Accumulator, I ² T Motor Accumulator.
Velocity	Profile Velocity, Commanded Velocity, Limited Velocity, Actual Motor Velocity, Actual Load Velocity, Unfiltered Motor Velocity, Velocity Error
Position	Commanded Position, Limited Position, Actual Load Position, Actual Motor Position, Following Error, Passive Load Position
Acceleration	Profile Acceleration
Voltage	Analog Command Bus Voltage Analog sin Input Analog cos Input Terminal Voltage Stepper Terminal Voltage Servo

Category	Trace Variable
Misc.	Motor Phase Angle, Amplifier Temperature, Hall States
Digital Inputs	Digital input line states
Digital Outputs	Digital output line states
Event Status Faults See Fault Configuration Parameters (p. 70).	Short Circuit, Amp Over Temperature, Over Voltage, Under Voltage, Motor Over Temperature, Feedback Error, Motor Phasing Error, Following Error, Command Input Fault, Amplifier Fault (a latched fault is active).
Event Status Warnings See Custom Event Functions (p. 52).	Current Limited, Voltage Limited, Positive Limit Switch, Negative Limit Switch, Following Warning, Velocity Limited, Acceleration Limited, Positive Software Limit, Negative Software Limit, Pos Outside of Tracking Window, Vel Outside of Tracking Window.
Event Status Misc. See Custom Event Functions (p. 52).	Amp Disabled by Hardware, Amp Disabled by Software, Attempting to Stop Motor, Motor Brake Active, PWM Outputs Disabled, Position Has Wrapped, Home Switch Active, In Motion, Phase Not Initialized.

3

Click **OK**.

15.4: Trigger Setup

Set up Scope trace trigger (manual setup)

1



Click Trigger Setup to open the screen:

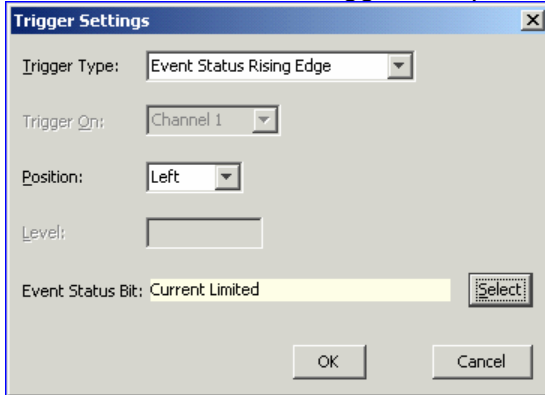

2

Choose from the settings described below:

Setting	Description
Trigger Type	<p>Selects trigger type.</p> <ul style="list-style-type: none"> • Immediate Trigger: Trace begins as soon as Record is pressed. • Rising Edge: Trace triggers when (after Record is pressed) the trigger signal rises through the trigger level setting. • Falling Edge: Trace triggers when (after Record is pressed) the trigger signal falls through the trigger level setting. • Above Level: Trace triggers when the trigger signal is greater than or equal to the trigger level setting. • Below Level: Trace triggers when the trigger signal is less than or equal to the trigger level setting. • Function Generator: Trace begins in synchronization with the <i>Function Generator</i>. • Move Start (position mode only): Trace begins in synchronization with the trajectory generator. • Event Status Rising Edge/Event Status Falling Edge: trigger on the rising or falling edge of changes to events chosen in the Event Status Bit setting (below). • Input Level High/Input Level Low: trigger when specified input is high or low. • Output Active/Inactive: trigger when specified output is active or inactive (note that outputs can be configured to be active when high or low). (Not available on Accelus or Junus.)
Trigger On	Selects which channel will be used as the trigger signal: 1, 2, 3, 4, 5, or 6.
Position	<p>Selects placement of the trigger event on the screen. (Value is not configurable for Immediate or Function Generator trigger types.).</p> <ul style="list-style-type: none"> • <i>Left</i> for optimal viewing of events following the trigger. • <i>Middle</i> for optimal viewing of events preceding and following the trigger. • <i>Right</i> for optimal viewing of events preceding the trigger.
Level	Sets the trigger level, in units appropriate to the channel selected.
Event Status Bit	With an event status trigger type selected, choose the event status word bit that will trigger the trace. For descriptions of the event status word bits, see Custom Event Functions (p. 52) .

15.5: Trace Time, Sample Rate and Single Trace

Trace Time sets the length of the recorded trace.

Sample Rate is the rate at which the signals are sampled. The rate depends on the trace time, the number of channels selected, and which variables are being traced.

Single Trace puts the scope in a single trace mode of operation. In this mode, the trigger is not re-armed after a trace until the user presses the **Record** button. Single Trace is automatically set by the generators in certain cases.

15.6: Scope Display Parameters

The user can set the line style and other scope screen preferences. Right-click on the scope screen to display the menus, as shown below.

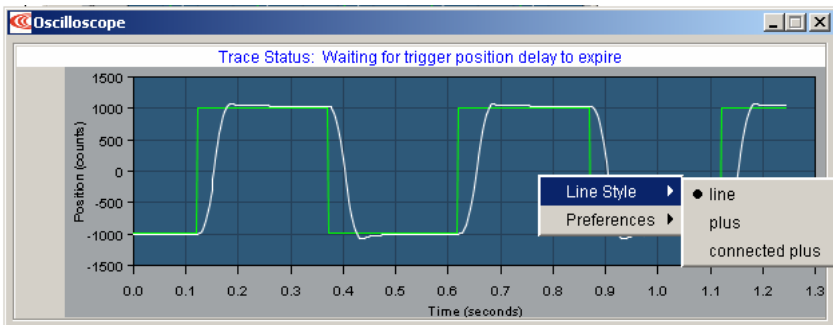

The Scope display parameters are described below.

Menu	Parameter	Description
Line Style	line	A line connects the plotted data points.
	plus	The Scope plots data points as plus signs, with no connecting line.
	connected plus	Data points are plotted as plus signs and are connected with a line.
Preferences	anti-aliasing	When anti-aliasing is selected, the Scope smoothes out any screen-related jaggedness in the displayed trace. Use of this feature may slow down the refreshing of traces on slow computers.
	grid	When selected a grid is displayed on the scope screen.

15.6.1: Auto Scale and Auto Scale Lock

The Scope automatically scales the display axes to optimally display all channels.

With Auto Scale Lock selected, the y-axis locks its scale for all subsequent traces.

15.6.2: Zoom

Zoom in on a Trace Segment

- 1 Hold the left mouse button down while dragging a box around the area of interest.

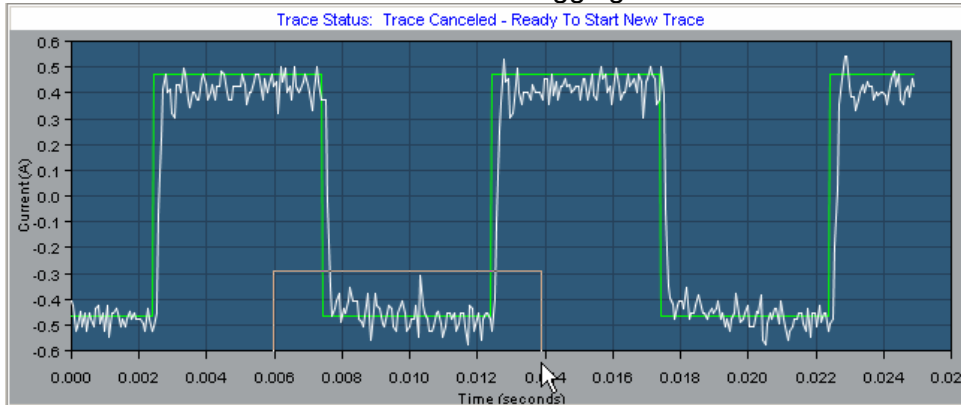

- 2 Release the button to let the display zoom in on the selected area.

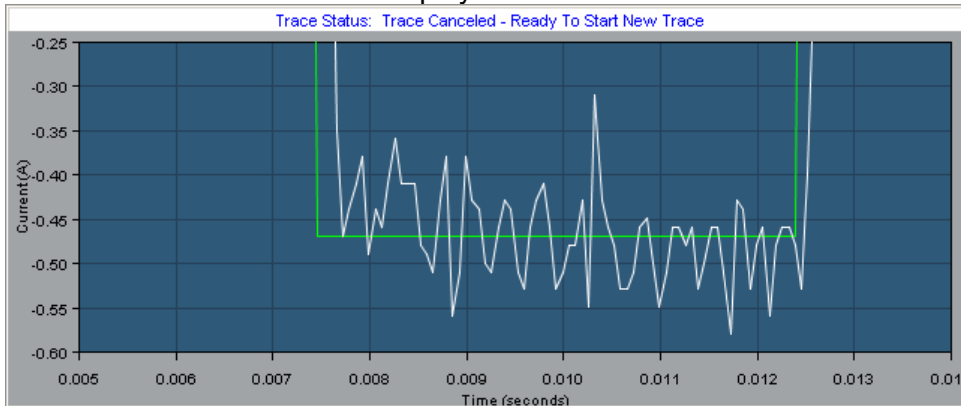

- 3 To restore the normal zoom level immediately, left-click anywhere on the trace. (Normal zoom level is also restored when the next trigger event occurs.)

15.7: Auto Setup

With **Auto Set Up** selected, if the function generator tab is active, CME 2 automatically sets the scope settings and the function generator's amplitude and frequency/period to best suit the function generator's *Apply To* and *Excitation* mode settings. If the *Profile* tab is active, CME 2 automatically sets the scope settings and sets a standard move into the profile generator. Changing any of the preset settings de-selects the Auto Set Up feature.

15.8: Measurement Tab

The *Measurement* tab allows you to measure and analyze data from up to three parameters during an interval defined by adjustable cursors. The Cursor Data area displays a parameter's values at the left and right cursor locations, and the difference between the two values. The Analysis area displays the minimum, maximum, average, and root mean square of the parameters during the cursor period.

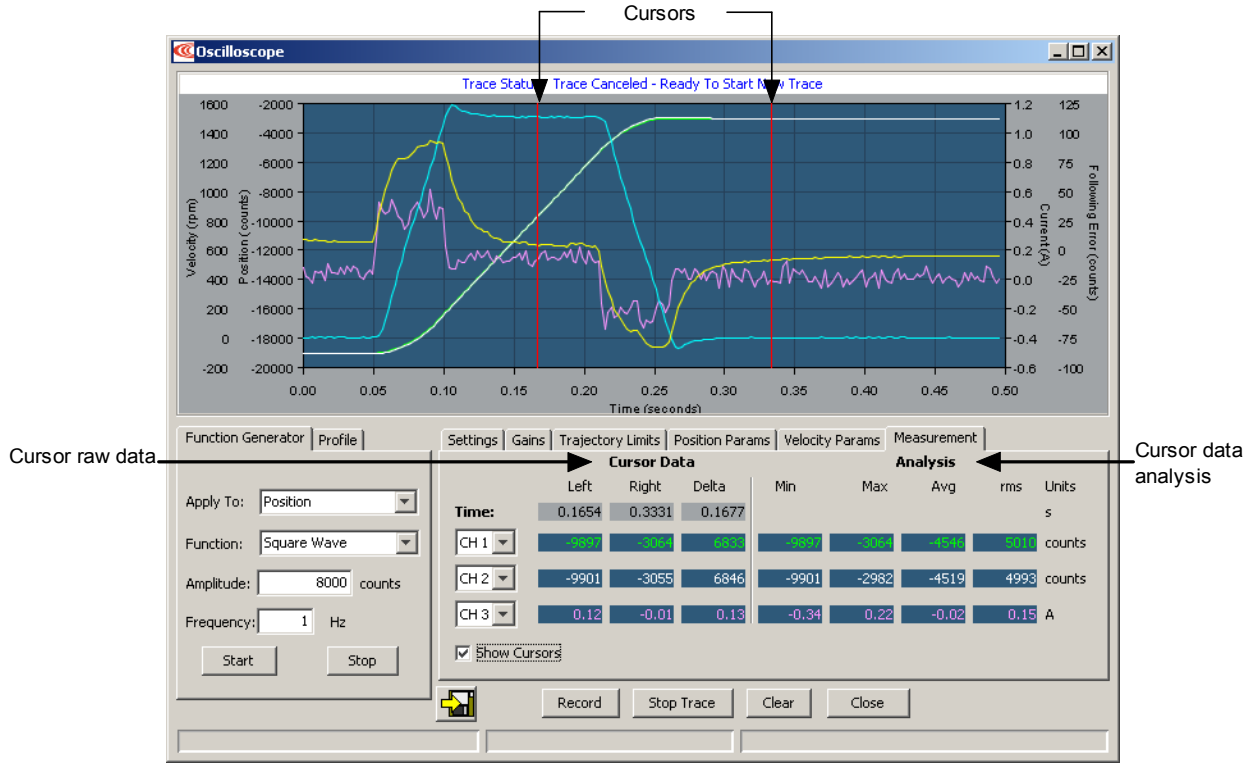

When **Show Cursors** is not set, the Cursor Data fields are inactive and the Analysis fields show calculations based on data from the entire trace cycle.

Basic Measurement Operations

- 1 Show Cursors To display cursors and activate the Cursor Data fields, set **Show Cursors**.
- 2 To move a cursor, click on the cursor and hold the left button while dragging the cursor to the desired location. Release the left button to place the cursor in the new location.
- 3 To select a parameter to measure and analyze within the cursors, choose a channel in one of the three channel lists on the *Measurement* tab:

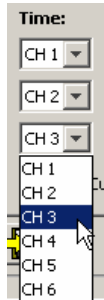

15.9: Control Loop Parameters

The Scope tool provides convenient access to all of the control loop parameters that might be used in tuning and diagnosing an amplifier. The user can adjust these parameters and see the results immediately on the scope. Control loop parameters are accessed through a set of tabs, shown below.

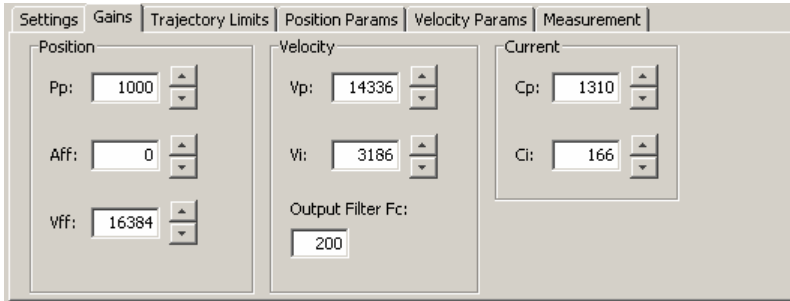

Note that the parameters represented on these tabs can also be accessed through the screens used to configure the control loops and the digital position input. Changing a value in the Scope tool automatically updates the value on the other screens where it appears, and vice versa.

Control loop parameter tab descriptions follow.

15.9.1: Gains Tab

The *Gains* tab provides access to all of the gains appropriate to the operating mode, as described below.

Modes	Gains	Description	For More Information
Position mode only	Pp	Position loop proportional gain.	Trajectory Limits (p. 113).
	Aff	Acceleration feed forward.	
	Vff	Velocity feed forward.	
Position or velocity mode only	Vp	Velocity loop proportional gain.	Velocity Loop Gains (p. 105). Low-Pass and Bi-Quad Filters (p. 169).
	Vi	Velocity loop integral gain.	
	Output Filter Fc	Velocity Loop Output Filter cut-off frequency.	
All modes	Cp	Current loop proportional gain.	Current Loop Gains (p. 101).
	Ci	Current loop integral gain.	
	ECp	Encoder Correction Gain.	Encoder Correction (p. 125).

15.9.2: Trajectory Limits Tab

In position mode, the *Trajectory Limits* tab can be used to set trajectory limits.

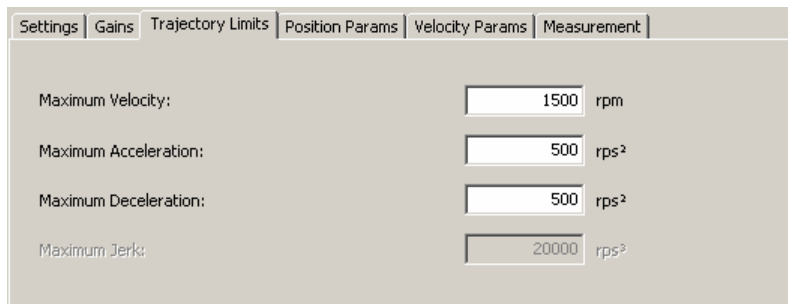

For more information on the velocity and acceleration limits, see [Trajectory Limits \(p. 113\)](#). For more information on the *Maximum Jerk* setting, see [Test S-Curve Profile \(p. 112\)](#).

15.9.3: Position Loop Parameters

In position mode, the *Position Params* tab can be used to set position loop parameters.

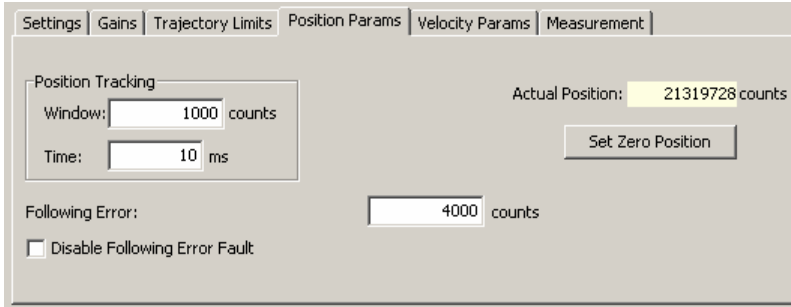

Set Zero Position sets the amplifier's actual position count to zero. For more information on the other settings, see [Position and Velocity Error Notes \(p. 72\)](#).

15.9.4: Velocity Loop Parameters

In position and velocity modes, the *Velocity Params* tab can be used to set velocity loop parameters.

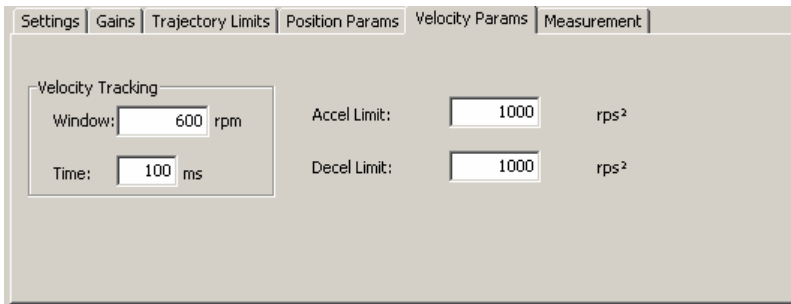

For information on the Velocity Tracking parameters, see [Position and Velocity Error Notes \(p. 72\)](#). For information on the limits, see [Velocity Loop Limits \(p. 104\)](#).

15.10: Scope Files

The Scope Tool allows you to save both scope settings and scope trace data. Saving the scope settings is useful for saving custom settings used for tests that are run frequently. Saving the trace data is useful for archiving the performance of a system so that it can be used as a reference at a later date for comparison.

15.10.1: Scope Settings Files

The Scope Tool File→Save Settings command allows you to save scope settings (settings on the *Function Generator*, *Profile*, and *Settings* tabs in a .sco file. The File→Restore Settings command restores them for quick setup.

Save scope settings:

- 1 On the *Function Generator*, *Profile*, and *Settings* tabs, choose the scope settings you wish to save.
- 2 Choose **File→Save Settings**.
- 3 When prompted, enter a *File Name*. If needed, navigate from the default *ScopeData* folder to another folder where you wish to store the file.
- 4 Click **Save** to save the .css file and close the screen.

Restore scope settings:

- 1 In the Scope Tool, choose **File→Restore Settings**.
 - 2 If needed, navigate from the default *ScopeData* folder to the folder containing the .css file.
 - 3 Highlight the filename and click **Open**.
-

15.10.2: Scope Trace Files

The Scope Tool can save trace data in Copley Controls scope files (.sco files) that can be opened later with the CME 2 *Trace Viewer*. Simultaneously, a version of the same trace is stored in a comma-separated text file (.csv) and a tab delimited file (.txt), either of which can be opened with a spreadsheet application such as Microsoft Excel (or other programs) for mathematical analysis. The format of the .csv and the .txt file is the same:

Column 1: time
Column 2: Trace Channel 1
Column 3: Trace Channel 2 (if used)
Column n: Trace Channel n (if used)

NOTE: By default, scope files are saved in the *ScopeData* folder in the CME 2 installation folder. For instance, c:\Program Files\Copley Motion\CME 2\ScopeData. Use these procedures to save and view trace files:

Save trace data:

- 1 Generate the trace you wish to save.
 - 2  In the Oscilloscope window, click the **Save to Disk** icon.
 - 3 When prompted, enter a *File Name*. If needed, navigate from the default *ScopeData* folder to another folder where you wish to store the file.
 - 4 Click **Save** to save the .sco, .txt, and .csv files in the same folder and close the screen.
-

View a trace file:

- 1 On the *Main* screen, choose **Tools**→**View Scope Files** to open the window.
- 2 Click **Open File**. When prompted, select the name of the file you wish to open. Then, click **Open** to display the file in the *Trace Viewer* window.

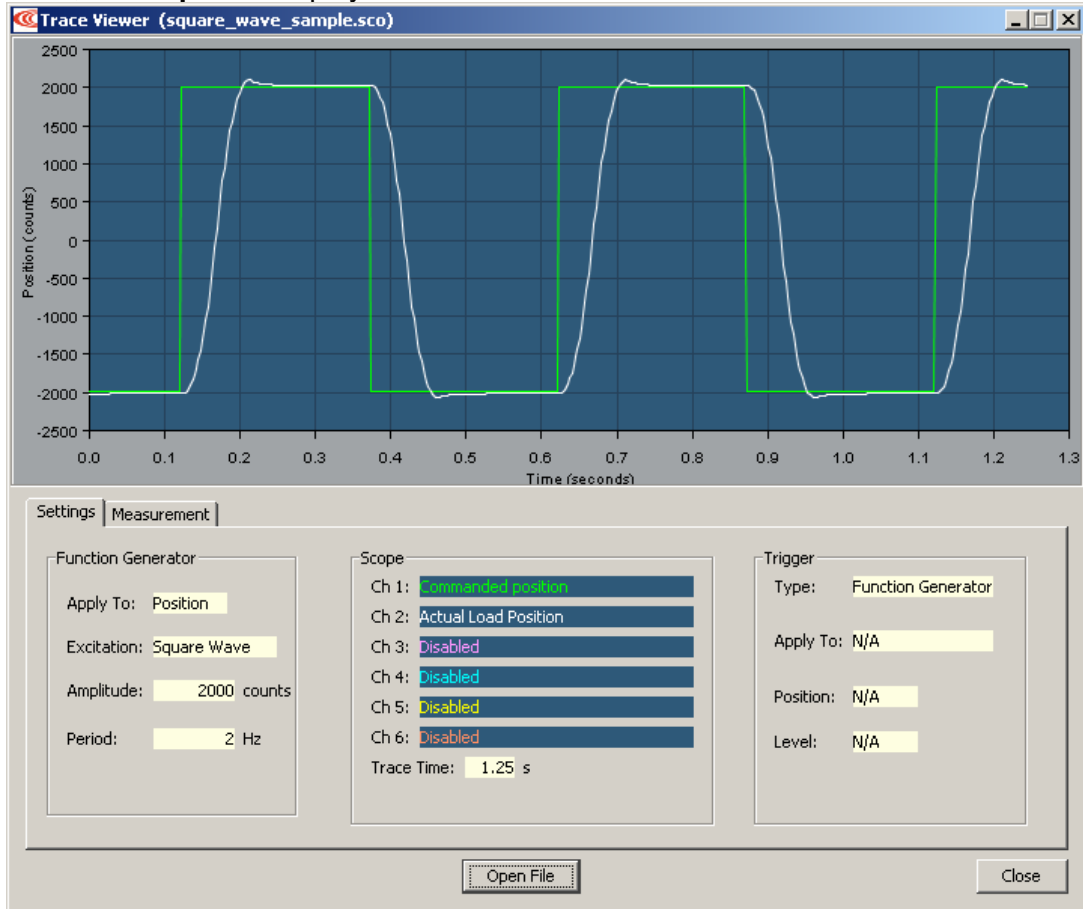

The *Measurement* tab allows you to measure and analyze data from up to three parameters during an interval defined by adjustable cursors. See [Measurement Tab \(p. 142\)](#).

CHAPTER

16: DATA, FIRMWARE, AND LOGS

This chapter describes how CME 2 manages amplifier data and firmware, how to download firmware, and use the amplifier logs.

- [Amplifier RAM and Flash Memory \(p. 150\)](#)
 - [Disk Storage of Amplifier and Motor Data Files \(p. 150\)](#)
 - [Data Management Tools \(p. 151\)](#)
 - [Amplifier Firmware \(p. 153\)](#)
 - [Error Log \(p. 155\)](#)
 - [Communications Log \(p. 156\)](#)
-

16.1: Amplifier RAM and Flash Memory

Amplifier RAM holds status data and certain user-entered data during operation. Its contents are flushed when the amplifier is reset or powered off. Flash memory permanently stores the data. The contents of flash are loaded into amplifier RAM at power-up or reset, as described below.

Amplifier RAM	Flash
Contents erased when amplifier is reset or powered off.	Permanent. Contents retained when the amplifier is reset or powered off.
Initial contents read from flash on power-up. Contents then updated in real time to reflect certain operational conditions and changes entered with CME 2 software. At any time, the user can use CME 2 to restore data from flash into amplifier RAM.	Modified only by using a Save to Flash tool or by closing certain screens (<i>Motor/Feedback</i> , <i>Basic Setup</i> , <i>Homing</i> , or <i>CAN Configuration</i>), whose contents are automatically saved to flash upon closing of the screen.

As described below, some data resides in flash only, some in amplifier RAM only, and some in both.

Data Resides In	Data
Flash only	This category includes all data represented on the <i>Motor/Feedback</i> screen, <i>Basic Setup</i> screen, and <i>CAN Configuration</i> screen. This data is automatically saved to flash as soon as its entry is confirmed (when the user clicks the appropriate Save to Flash button, or closes the screen).
Flash and amplifier RAM	Includes all user-entered data represented on other screens, such as gains, limits, and I/O, faults, and regen settings. Initial values for this data are factory-set in flash. They are loaded from flash to amplifier RAM with each power-up or amplifier reset. This data is saved to flash only when a user clicks the appropriate Save to Flash button. It is flushed from amplifier RAM with each power-down or amplifier reset.
Amplifier RAM only	Includes operating status data such as actual position, actual current, and amplifier temperature. Such data is never stored in flash. It is flushed from amplifier RAM with each power-down or amplifier reset.

16.2: Disk Storage of Amplifier and Motor Data Files

At any time, the user can save certain data from amplifier RAM and flash memory to a file on disk. From the *Main* screen, the user can save all user-entered data represented on all screens (the data described as [Flash only](#) and [Flash and amplifier RAM](#) on p. 150). This data is saved in a Copley Controls amplifier data file with a *.ccx* filename extension.

From the *Motor/Feedback* screen, the user can save all data represented on the *Motor/Feedback* screen. This data is saved in a Copley Controls motor data file with a *.ccm* filename extension.

A *.ccx* file can be restored to return the amplifier to a previous state or to copy settings from one amplifier to another, as described in [Copy Amplifier Data](#) (p. 159).

16.3: Data Management Tools

16.3.1: Amplifier Data Management Tools

Operations performed using the amplifier data management tools at the top of the *Main* screen (shown below) affect amplifier settings, including motor/feedback data. (CVM Control Program data is not saved by these operations.)

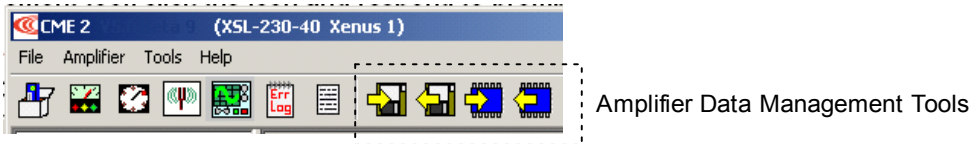

The amplifier data management tools are described below.

Icon	Name	Description
	Save amplifier data to disk	Saves all data represented on all screens to a disk file with a .ccx filename extension.
	Restore amplifier data from disk	Restores amplifier and motor data from a .ccx file to the PC and amplifier RAM and flash memory. Note that only certain data is saved to flash by this operation (the data described as Flash only on p. 150). To assure that all data (including the data described as Flash and amplifier RAM) is stored in flash, use the <i>Save amplifier data to flash</i> tool.
	Save amplifier data to flash	Saves contents of amplifier RAM to amplifier flash memory.
	Restore amplifier data from flash	Restores contents of amplifier flash memory to amplifier RAM.

To use a data management tool, click the icon and respond to prompts.

16.3.2: Motor Data Management Tools

Operations performed using the data management tools at the bottom of the *Motor/Feedback* screen (shown below) affect only user-entered data that is represented on the *Motor/Feedback* screen.

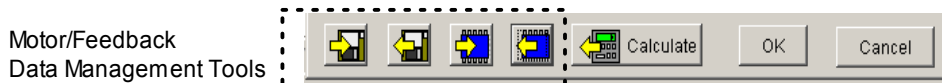

The motor data management tools are described below.

Icon	Name	Description
	Save motor data to disk	Saves only motor/feedback data from the PC to a disk file with a .ccm filename extension. Amplifier data that is not represented on the <i>Motor/Feedback</i> screen is not saved in this file, and this operation does not affect any .ccx files.
	Restore motor data from disk	Restores only motor data from a disk file with a .ccm filename extension to the PC. Amplifier data that is not represented on the <i>Motor/Feedback</i> screen is not affected.
	Save motor data to flash	Saves the contents of the <i>Motor/Feedback</i> screen from PC to amplifier flash memory. Amplifier data that is not represented on the <i>Motor/Feedback</i> screen is not saved. Can be used to assure that all changes are saved to flash without closing the <i>Motor/Feedback</i> screen.
	Restore motor data from flash	Restores only motor data from amplifier flash memory to the PC. Amplifier data that is not represented on the <i>Motor/Feedback</i> screen is not affected. Can be used before closing the <i>Motor/Data</i> screen to restore settings to the previously saved values.

To use a data management tool, click the icon and respond to prompts.

16.3.3: Save MACRO File for Delta Tau Controllers

This feature is available only on Copley MACRO amplifiers such as the Accelnet MACRO, with a minimum firmware version of 1.2.

Save a MACRO file:

- 1 On the CME 2 Main screen, choose **File**→**Save MACRO File** to open the MACRO File Save window:

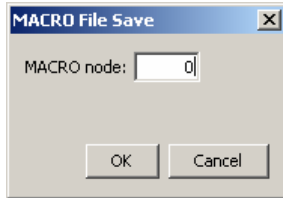

- 2 Enter the ID of the MACRO node with the settings you want to save and click **OK**.
- 3 When prompted, enter a *File Name*. If needed, navigate from the default *AmpData* folder to another folder where you wish to store the file.
- 4 Click **Save** to save the *.pmc* file in the same folder and close the screen.

16.4: Amplifier Firmware

The amplifier's flash memory holds the amplifier's firmware. As needed, perform the following steps to obtain new firmware and download it to amplifier flash memory.

NOTE: Firmware can only be downloaded to an amplifier via a direct serial port or CAN connection between the amplifier and the PC. CME 2 does not support downloading firmware to a node amplifier via a multi-drop gateway amplifier.

NOTE: To check the firmware version currently loaded, click the Amplifier Properties button or choose **Help→About**.

WARNING: Do not power down or disconnect the amplifier during firmware download.

Download Firmware to the Amplifier

- 1 On the *Main* screen choose **Tools→Download Firmware** to open the *Download Firmware* window.

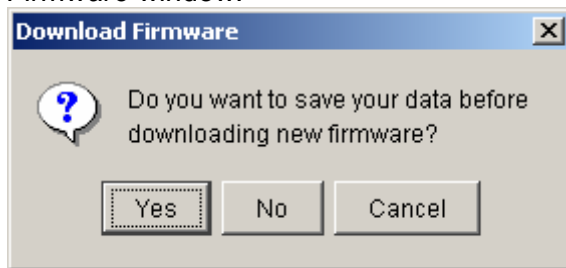

- 2 To download new firmware without saving amplifier and motor data, click **No** and then proceed to Step 4.
- 3 To save amplifier and motor data for backup purposes before downloading firmware, click **Yes**.

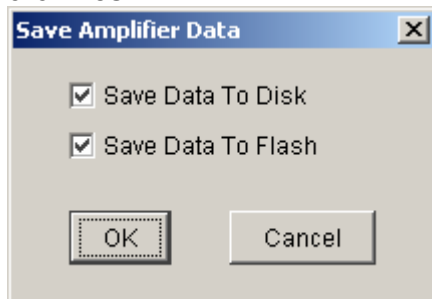

- Choose whether to save to disk, flash, both, or neither.
- Click **OK** to save data and continue to select a firmware image, or click **Cancel** to continue without saving data.
- If *Save Data to Disk* was selected, use the *Save Amplifier Data to Disk* screen to browse to the folder where you want to save the .ccx file. Then enter a name in the *Name* field. Then click **Save**.

When the Firmware Images window appears, proceed to Step 4.

Continued...

...Download Firmware to the Amplifier, continued:

- 4 Use the *Firmware Images* window to locate and select a firmware image file.

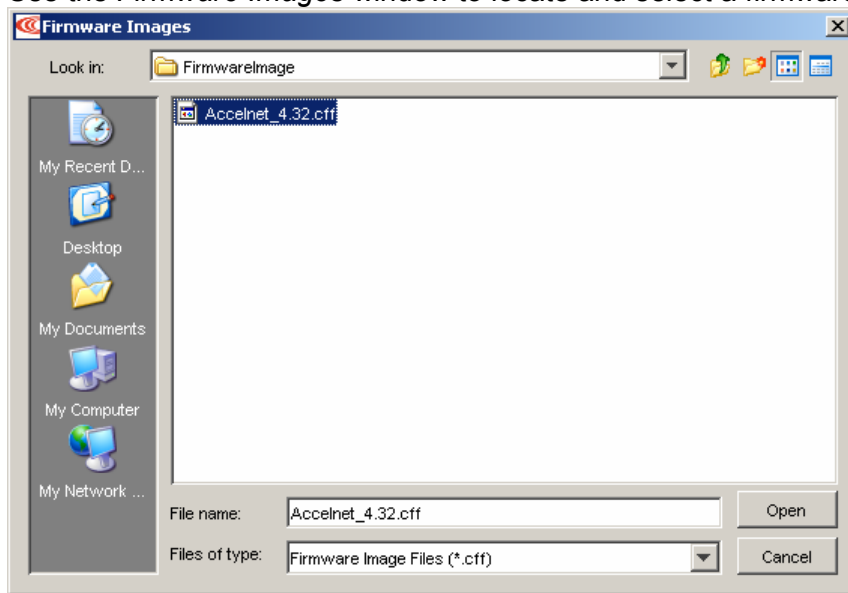

- 5 Click **Open** to begin the download. A message window displays a series of progress messages:

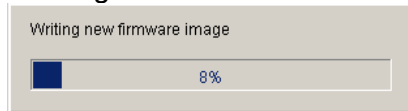

When the message window closes, the firmware download is complete.

16.5: Error Log

Copley amplifiers track faults and warnings in a log in flash memory.

View the CME 2 Error Log

1



Click the **Error Log** tool on the Main screen.

2

Click a tab to view a section of the log:

Tab	Contents
Active	Type and description of each active fault and warning. The contents of this tab are automatically refreshed as new events occur.
History	Type, description, and time of occurrence of each fault and most warnings since the log was last cleared. The contents of this tab are not refreshed automatically as new events occur. The contents are refreshed only when the tab is displayed or when Refresh is clicked.
Frequency	Type, description, and frequency of each fault and warning that has occurred since the log was last cleared. The contents are refreshed only when the tab is displayed or when Refresh is clicked.
CAN Network	(Under CAN control only.) Status of CAN bus. Lists warnings and errors.

3

To update the contents of the *History* or *Frequency* tabs, click **Refresh**.

4



To save the log to a disk file, click the **Save to Disk** icon on the log screen. Then navigate to the appropriate folder, enter a *File Name* for the log, and click **Save**.

5

To clear the log if needed, press **Clear Log**. (Contents cannot be recovered.)

6

To close the log screen, click **Close**.

16.6: Communications Log

The communications log tracks all communications between CME 2 and the amplifier. The log is maintained in the PC's RAM. Typically it is used only on request of customer service for troubleshooting purposes. When required, perform the following steps to manage the tracking and storage of these messages.

NOTE: Do not leave the Enable Logging control selected for any longer than necessary. Leaving it enabled for long periods can affect the PC's performance.

View the CME 2 Communications Log

- 1 On the *Main* screen, choose **Tools**→**Communications Log** to open the screen:

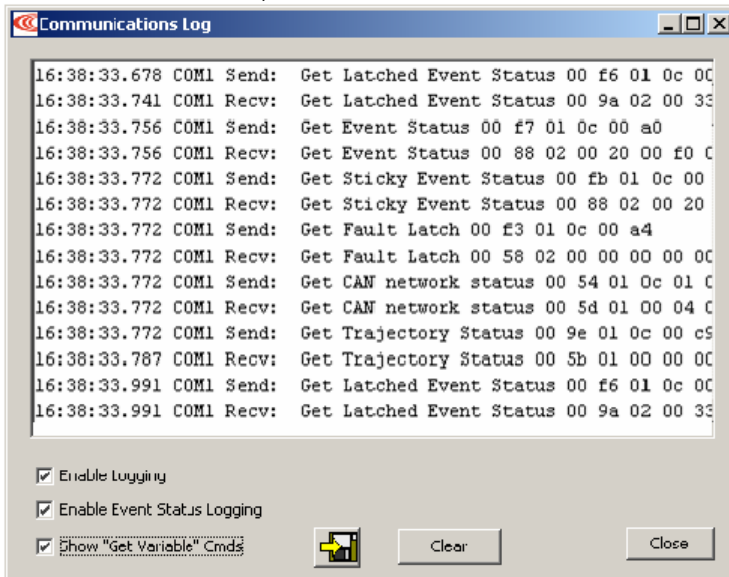

- 2 Select the logging options described below.

Option	Description
Enable Logging	When selected, logging is enabled and all communications, with the exception of status messages, are recorded in the log
Enable Event Status Logging	When selected, status messages are included in the log. Note that Show "Get Variable" Ccmds must also be checked to log Event Status commands.
Show "Get Variable" Ccmds	When selected, "Get Variable" commands are added to the log.

- 3 To clear the log contents from the PC's RAM, press **Clear**.
NOTE: The log is limited to 2000 lines. When it reaches that limit, CME 2 automatically clears the oldest 1000 lines.



To save the log contents from the PC's RAM to a disk file, click the **Save to Disk** icon. When prompted, enter a *File name*. Then, click **Save** to save the log file and close the window.

CHAPTER

17: VIRTUAL AMPLIFIER

Virtual amplifiers can be used for training and for creating motor data files off line.

A new virtual amplifier can be created based on a virtual amplifier template file (.ccv).

CME 2 includes a set of .ccv files representing Copley Controls amplifiers. Perform these steps to create a virtual amplifier:

1 Start CME 2 (p. 13).

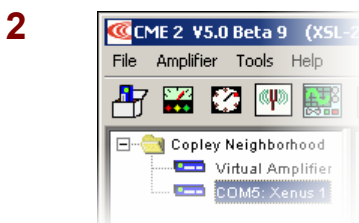

Choose **Virtual Amplifier** from the *Copley Neighborhood* tree to open the *Open Virtual Amplifier* screen:

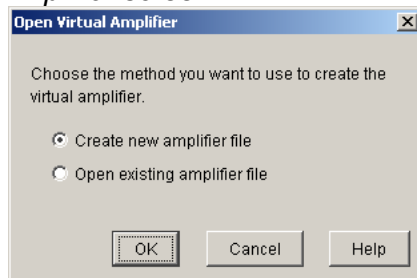

3 (To open a virtual amplifier from an existing amplifier file, skip to [Step 4](#) now.)
To create a new virtual amplifier file based on a virtual amplifier template file:

- Select Create new amplifier.
- When prompted, highlight the virtual amplifier template filename (.ccv) that represents the type of virtual amplifier you wish to create.
- Click Open to open the file and the *Basic Setup* screen.

Motor and amplifier values may now be viewed, entered, and adjusted.

4 Alternately, to open an existing amplifier file:

- Select Open existing amplifier file.
- When prompted, highlight the name of the file you wish to open.
- Click **Open**.

Motor and amplifier values may now be viewed, entered, and adjusted.

APPENDIX

A: COPY AMPLIFIER DATA

Perform steps 1-5 to configure an amplifier/motor pair by copying a .ccx file that was prepared for the amplifier/motor combination.

To load a CVM Program file as well, also perform step 6, and to load a Cam Table file, also perform step 7.

- 1 Make sure the amplifier is connected to the PC using the serial or CAN connector.

- 2  Start CME 2 (p. 13).

- 3 Use the command appropriate for your starting point:



Starting from the *Main* screen, click **Restore amplifier data from disk**.

- OR  Starting from the *Basic Setup* screen, click **Load ccx File**.

- 4 When prompted, navigate to the folder containing the appropriate .ccx file. Highlight the file name and then click **Open** to load the file data into amplifier RAM.

- 5  On the *Main* screen, click **Save to Flash** to save the new settings to flash memory.

- 6 If you do not need to load a CVM Control Program, skip to Step 7. To load a CVM Control Program, choose **File→Restore CVM Control Program**. When prompted, navigate to the folder containing the appropriate .ccp file. Highlight the file name and then click **Open** to load the file data into flash memory.

This procedure also results in the setting of the Indexer 2 Program option Enable Control Program on Startup. This configures the program to auto start when the amplifier is powered up or reset.

- 7 If you do not need to load a set of Cam Tables, the process is complete. To load a set of Cam Tables, choose **File→Restore Cam Tables**. When prompted, navigate to the folder containing the appropriate .cct file. Highlight the file name and then click **Open** to load the file data into flash memory.

TIP: When copying amplifier data to multiple amplifiers in a production environment, consider locking CME 2 to prevent accidental changes to settings. See [Lock/Unlock CME 2 Controls \(p. 161\)](#).

APPENDIX

B: LOCK/UNLOCK CME 2 CONTROLS

Optionally lock CME 2 to prevent changes to amplifier settings.

TIP: Lock CME 2 to prevent accidental changes to settings when copying amplifier files.

- 1 On the Main screen choose **Tools**→**CME 2 Lock/Unlock**.

- 2 Set a new password in the *Password* and *Verify Password* fields.

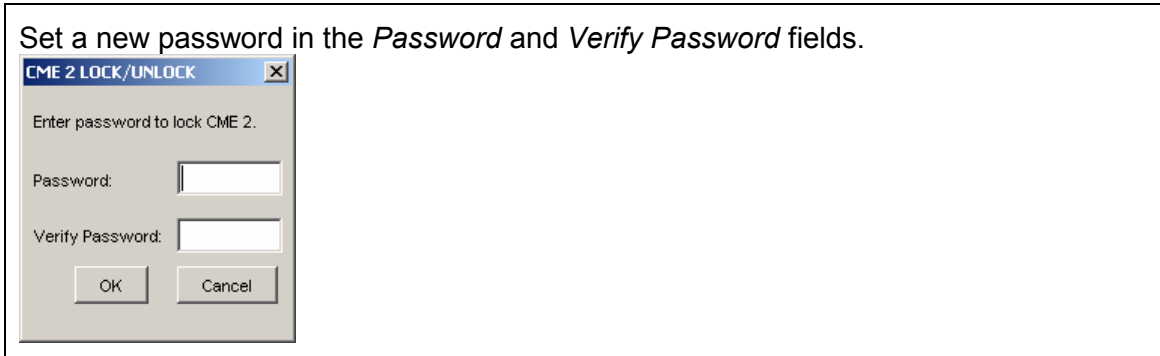

- 3 Click **OK** to lock out amplifier setting controls.

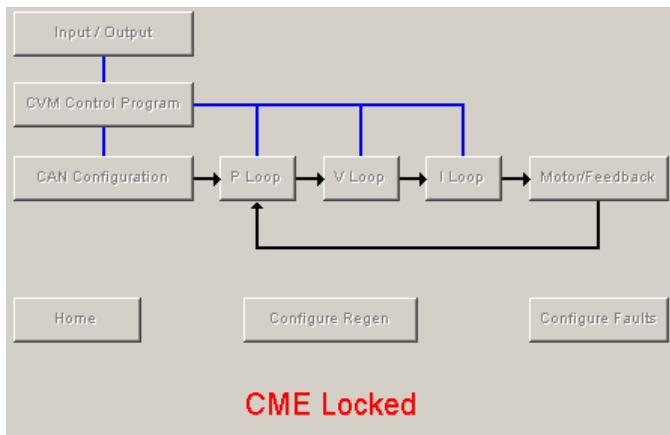

WHEN CME 2 IS LOCKED:

User can not change any amplifier or motor settings.

User can download amplifier and motor files and Cam Tables, jog the motor, run scope functions and profiles, and monitor amplifier performance with the scope and control panel.

- 4 To unlock, choose **Tools**→**CME 2 Lock/Unlock**.

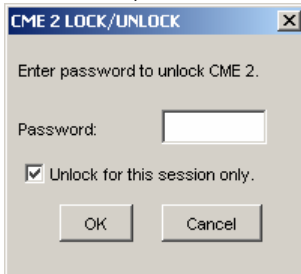

- 5 Enter the password. Unlock for this session or until locked again. Click **OK**.

APPENDIX

C: I²T TIME LIMIT ALGORITHM

This chapter describes the algorithm used to implement the I²T limit.

C.1: I²T Algorithm

C.1.1: I²T Overview

The I²T current limit algorithm continuously monitors the energy being delivered to the motor using the I²T Accumulator Variable. The value stored in the I²T Accumulator Variable is compared with the I²T setpoint that is calculated from the user-entered Peak Current Limit, I²T Time Limit, and Continuous Current Limit. Whenever the energy delivered to the motor exceeds the I²T setpoint, the algorithm protects the motor by limiting the output current or generates a fault.

C.1.2: I²T Formulas and Algorithm Operation

Calculating the I²T Setpoint Value

The I²T setpoint value has units of Amperes²-seconds (A²S) and is calculated from programmed motor data. The setpoint is calculated from the Peak Current Limit, the I²T Time Limit, and the Continuous Current Limit as follows:

$$\text{I}^2\text{T setpoint} = (\text{Peak Current Limit}^2 - \text{Continuous Current Limit}^2) * \text{I}^2\text{T Time Limit}$$

I²T Algorithm Operation

During amplifier operation, the I²T algorithm periodically updates the I²T Accumulator Variable at a rate related to the output current Sampling Frequency. The value of the I²T Accumulator Variable is incrementally increased for output currents greater than the Continuous Current Limit and is incrementally decreased for output currents less than the Continuous Current Limit. The I²T Accumulator Variable is not allowed to have a value less than zero and is initialized to zero upon reset or +24 Vdc logic supply power-cycle.

Accumulator Increment Formula

At each update, a new value for the I²T Accumulator Variable is calculated as follows:

$$\begin{aligned} \text{I}^2\text{T Accumulator Variable}_{n+1} = & \\ & \text{I}^2\text{T Accumulator Variable}_n \\ & + (\text{Actual Output Current}_{n+1}^2 - \text{Continuous Current Limit}^2) * \text{Update period} \end{aligned}$$

After each sample, the updated value of the I²T Accumulator Variable is compared with the I²T setpoint. If the I²T Accumulator Variable value is greater than the I²T Setpoint value, then the amplifier limits the output current to the Continuous Current Limit. When current limiting is active, the output current will be equal to the Continuous Current Limit if the commanded current is greater than the Continuous Current Limit. If instead the commanded current is less than or equal to the Continuous Current Limit, the output current will be equal to the commanded current.

C.1.3: I²T Current Limit Algorithm – Application Example

I²T Example: Parameters

Operation of the I²T current limit algorithm is best understood through an example. For this example, a motor with the following characteristics is used:

- Peak Current Limit – 12 A
- I²T Time Limit – 1 S
- Continuous Current Limit – 6 A

From this information, the I²T setpoint is:

$$\text{I}^2\text{T setpoint} = (12 \text{ A}^2 - 6 \text{ A}^2) * 1 \text{ S} = 108 \text{ A}^2\text{S}$$

See the example plot diagrams on the next page.

I²T Example: Plot Diagrams

The plots that follow show the response of an amplifier (configured w/ I²T setpoint = 108 A²S) to a given current command. For this example, DC output currents are shown in order to simplify the waveforms. The algorithm essentially calculates the RMS value of the output current, and thus operates the same way regardless of the output current frequency and wave shape.

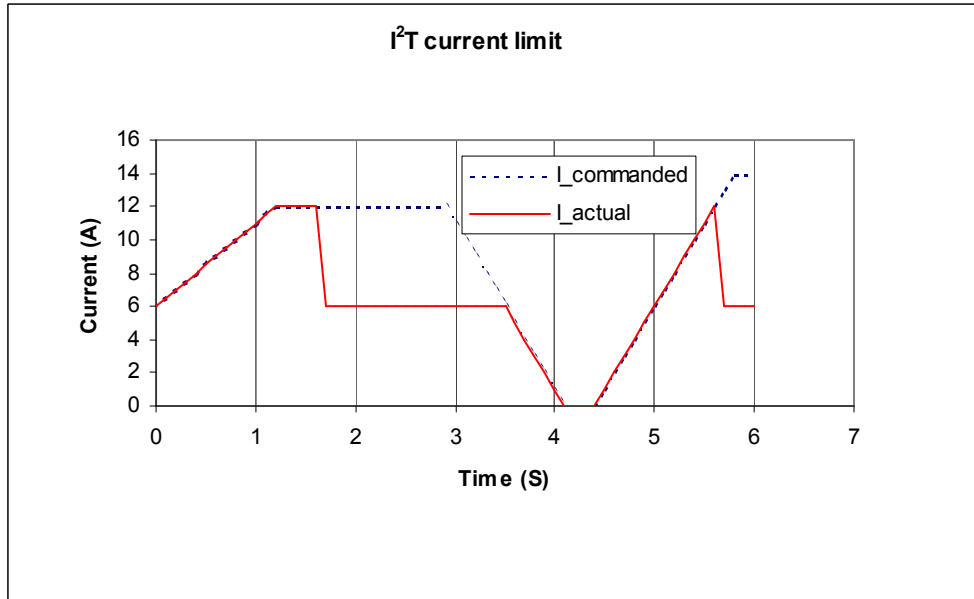

A)

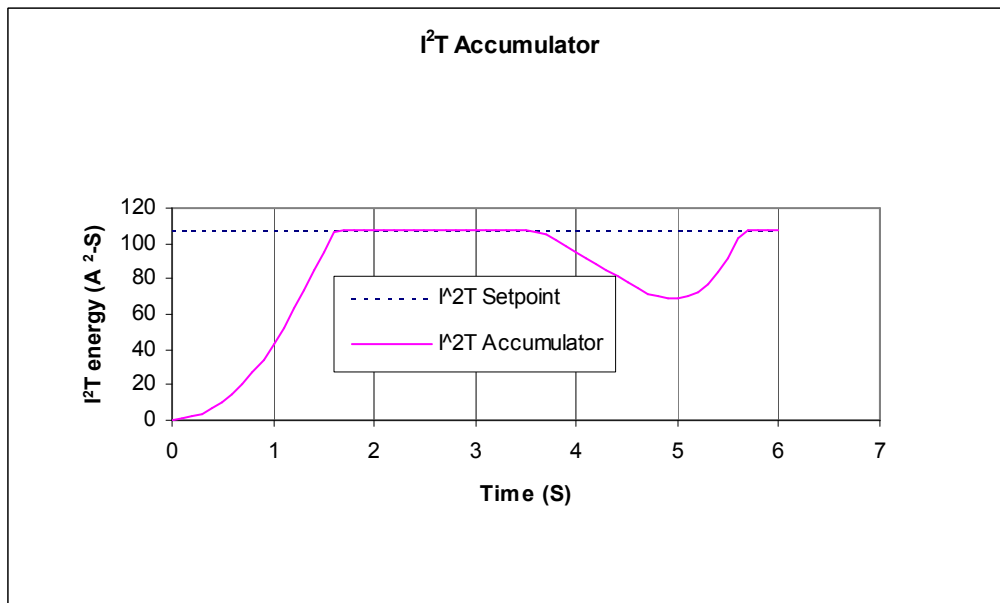

B)

At time 0, plot diagram A shows that the actual output current follows the commanded current. Note that the current is higher than the continuous current limit setting of 6 A. Under this condition, the I²T Accumulator Variable begins increasing from its initial value of zero. Initially, the output current linearly increases from 6 A up to 12 A over the course of 1.2 seconds. During this same period, the I²T Accumulator Variable increases in a non-linear fashion because of its dependence on the square of the current.

At about 1.6 seconds, the I²T Accumulator Variable reaches a values equal to the I²T setpoint. At this time, the amplifier limits the output current to the continuous current limit

even though the commanded current remains at 12 A. The I²T Accumulator Variable value remains constant during the next 2 seconds since the difference between the actual output current and the continuous current limit is zero.

At approximately 3.5 seconds, the commanded current falls below the continuous current limit and once again the output current follows the commanded current. Because the actual current is less than the continuous current, the I²T Accumulator Variable value begins to fall incrementally.

The I²T Accumulator Variable value continues to fall until at approximately 5.0 seconds when the commanded current goes above the continuous current limit again. The actual output current follows the current command until the I²T Accumulator Variable value reaches the I²T setpoint and current limiting is invoked.

C.2: I²T Scope Trace Variables

Two Scope Tool trace variables are available for monitoring whether the I²T accumulator is accumulating or discharging.

The I²T Amplifier Accumulator variable evaluates the accumulator against the factory set current limits of the amplifier.

The I²T Motor Accumulator variable evaluates the accumulator against the user-programmed current loop values.

The value shown in the scope has been normalized so that 100% equals the I²T setpoint.

When either trace variable line reaches 100%, current limiting will be invoked.

For instructions on using these variables in the Scope Tool, see [Trace Channel Variable Parameters](#) (p. 138).



APPENDIX

D: LOW-PASS AND BI-QUAD FILTERS

CME 2 supports 2 classes of filters on the analog input and on the Velocity Loop command and output: the Low-Pass and the Custom Bi-Quad. The Low-Pass filter class includes the Single-Pole and the Two-Pole Butterworth filter types.

Set Filter Parameters:

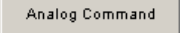
1

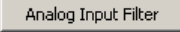
Velocity Loop Filters	Analog Input Filter
 Click V Loop to open the <i>Velocity Loop</i> screen.	 Click Analog Command to open the <i>Analog Command</i> screen.
  Click Command Filter or Output Filter to open the filter screen.	 Click Analog Input Filter to open the filter screen.

The velocity loop and analog input filter controls are identical. The filter window label indicates the source of the filter call and the target of the filter changes. The sample below shows the Velocity Loop Output Filter screen.

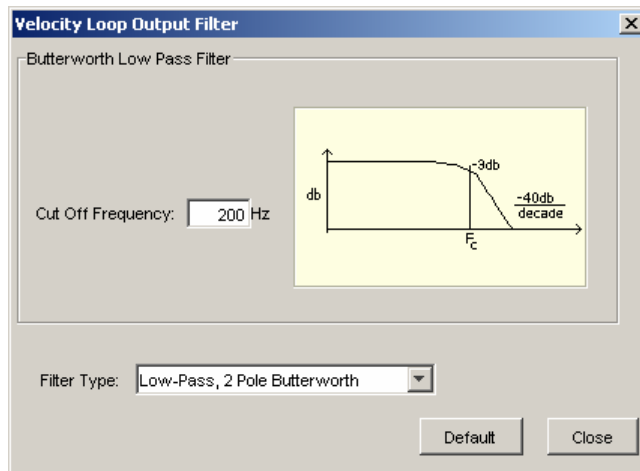

2 Adjust the filter settings described below.

Filter Class/Type	Description
Low-Pass/ Single Pole	The single-pole low pass filter is the simplest filter. The value entered in the <i>Cut-off Frequency</i> field provides the -3 db point. The filter will attenuate at -20 db/decade past the cut-off frequency, reducing excitation of high frequency resonance.
Low-Pass/ 2 Pole Butterworth	The Butterworth filter is a maximally flat low pass filter. This second order two-pole filter has a damping ratio of 0.707 and produces no peaking in the Bode plot. The value entered in the <i>Cut off Frequency</i> field provides the -3 db point. The filter attenuates at -40 db/decade past the cut off frequency. The phase-lag at lower frequencies is greater than the phase lag of other second order filters that exhibit more peaking.
Custom Bi-Quad	The Bi-Quadratic filter has two quadratic terms: one in the numerator, and one in the denominator. The numerator affects the filter's two zeros and the denominator affects the filter's two poles. Many filter classes and types can be expressed in the Bi-Quad form by entering the coefficients. The coefficients can be calculated using any commercially available math software package and entered as floating point numbers. However, due to the fixed-point representation, the numbers may be rounded.

APPENDIX

E: HOMING METHODS

This appendix describes the homing methods that can be chosen using the CME 2 homing controls described in [Homing \(p. 127\)](#).

Contents include:

Section	Page
E.1: Homing Methods Overview	172
E.2: Legend to Homing Method Descriptions	172
E.3: Homing Method Descriptions	173
E.3.1: Set current position as home	173
E.3.2: Next Index	173
E.3.3: Limit Switch	174
E.3.4: Limit Switch Out to Index	175
E.3.5: Hardstop	176
E.3.6: Hardstop Out to Index	177
E.3.7: Home Switch	178
E.3.8: Home Switch Out to Index	179
E.3.9: Home Switch In to Index	180
E.3.10: Lower Home	181
E.3.11: Upper Home	182
E.3.12: Lower Home Outside Index	183
E.3.13: Lower Home Inside Index	184
E.3.14: Upper Home Outside Index	185
E.3.15: Upper Home Inside Index	186

E.1: Homing Methods Overview

There are several homing methods. Each method establishes the:

- Home reference (limit or home switch transition or encoder index pulse)
- Direction of motion and, where appropriate, the relationship of the index pulse to limit or home switches.

E.2: Legend to Homing Method Descriptions

As highlighted in the example below, each homing method diagram shows the starting position on a mechanical stage. The arrow line indicates direction of motion, and the circled H indicates the home position. Solid line stems on the index pulse line indicate index pulse locations. Longer dashed lines overlay these stems as a visual aid. Finally, the relevant limit switch is represented, showing the active and inactive zones and transition.

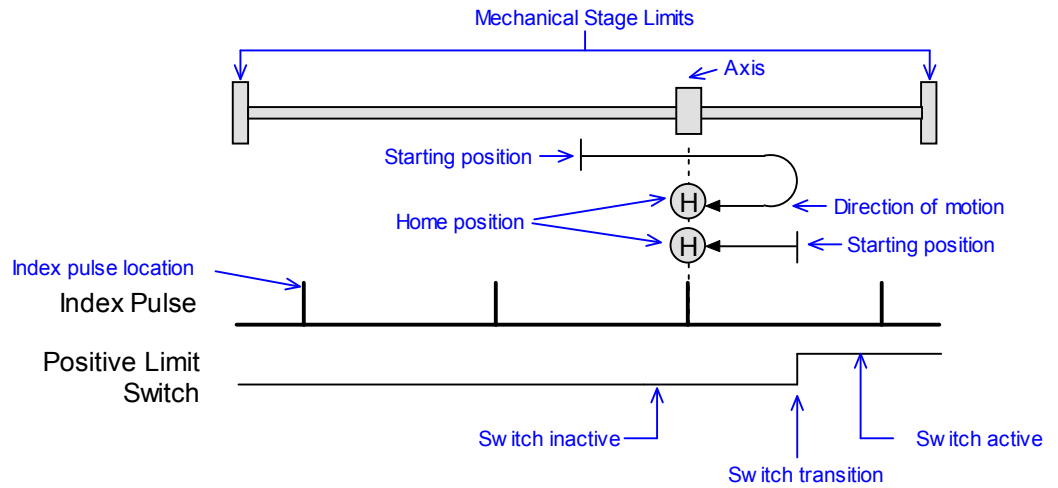

Note that in the homing method descriptions, negative motion is leftward and positive motion is rightward.

E.3: Homing Method Descriptions

E.3.1: Set current position as home

The current position is the home position.

E.3.2: Next Index

Direction of Motion: Positive

Home is the first index pulse found in the positive direction. Direction of motion is positive. If a positive limit switch is activated before the index pulse, an error is generated.

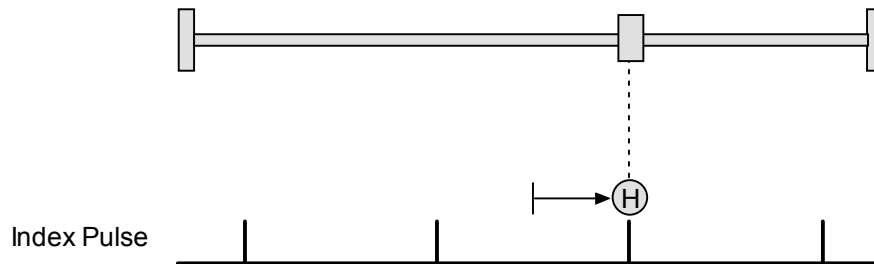

Direction of Motion: Negative

Home is the first index pulse found in negative direction. Direction of motion is negative. If a negative limit switch is activated before the index pulse, an error is generated.

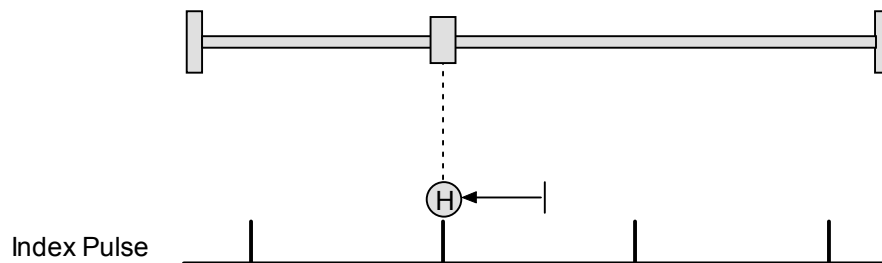

E.3.3: Limit Switch

Direction of Motion: Positive

Home is the transition of the positive limit switch. Initial direction of motion is positive if the positive limit switch is inactive.

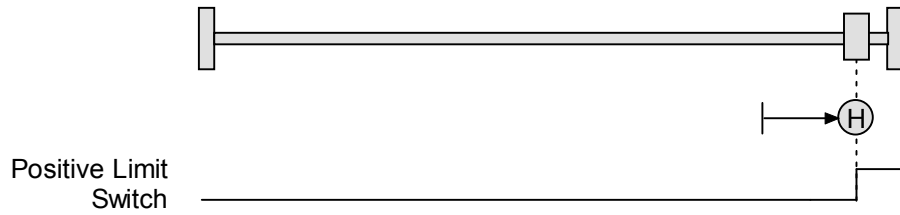

Direction of Motion: Negative

Home is the transition of negative limit switch. Initial direction of motion is negative if the negative limit switch is inactive.

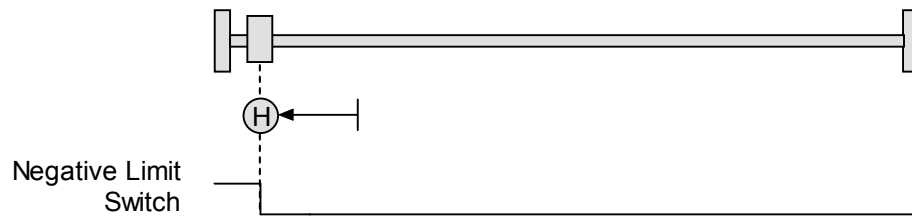

E.3.4: Limit Switch Out to Index

Direction of Motion: Positive

Home is the first index pulse to the negative side of the positive limit switch transition. Initial direction of motion is positive if the positive limit switch is inactive (shown here as low).

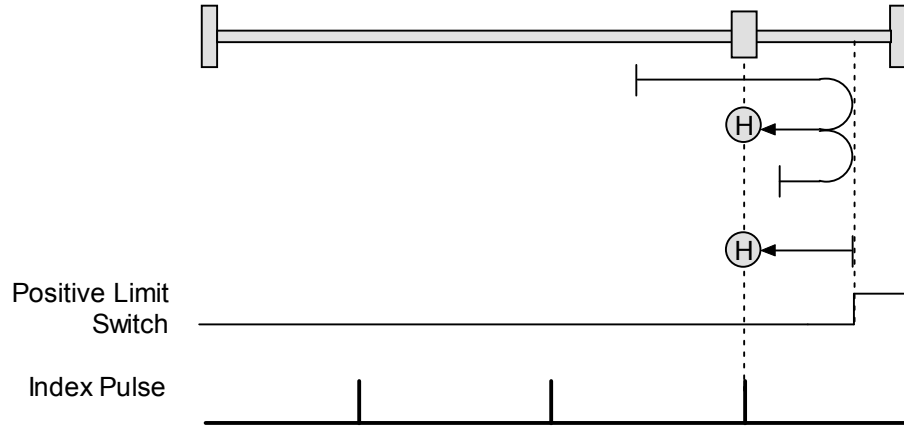

Direction of Motion: Negative

Home is the first index pulse to the positive side of the negative limit switch transition. Initial direction of motion is negative if the negative limit switch is inactive (shown here as low).

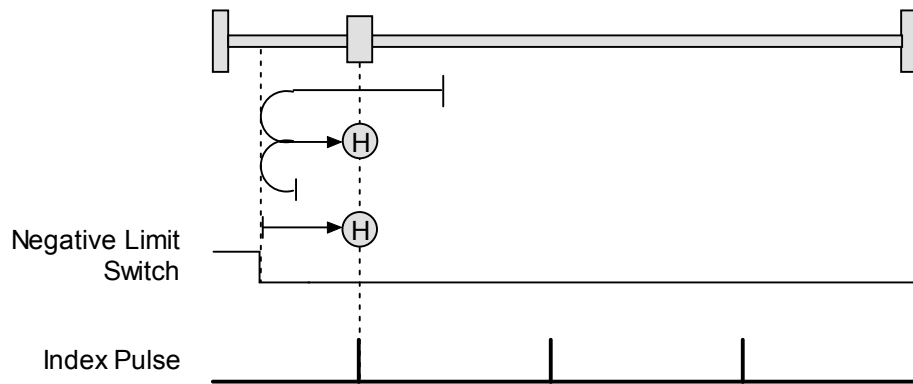

E.3.5: Hardstop

Direction of Motion: Positive

Home is the positive hard stop. Direction of motion is positive. In servo modes, the hard stop is reached when the amplifier outputs the homing Current Limit continuously for the amount of time specified in the Delay Time.

If a positive limit switch is activated before the hard stop, an error is generated.

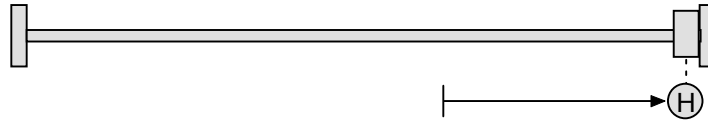

Direction of Motion: Negative

Home is the negative hard stop. Direction of motion is negative. The hard stop is reached when the amplifier outputs the homing Current Limit continuously for the amount of time specified in the Delay Time. If a negative limit switch is activated before the hard stop, an error is generated.

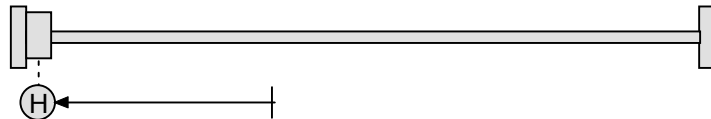

Hardstop Methods in Stepper Mode

In Stepnet amplifiers operating in stepper mode with an encoder, the hard stop is reached when the following error is exceeded. When using hardstop methods in stepper mode, do not disable following error.

E.3.6: Hardstop Out to Index

Direction of Motion: Positive

Home is the first index pulse on the negative side of the positive hard stop. Initial direction of motion is positive. The hard stop is reached when the amplifier outputs the homing Current Limit continuously for the amount of time specified in the Delay Time. If a positive limit switch is activated before the hard stop, an error is generated.

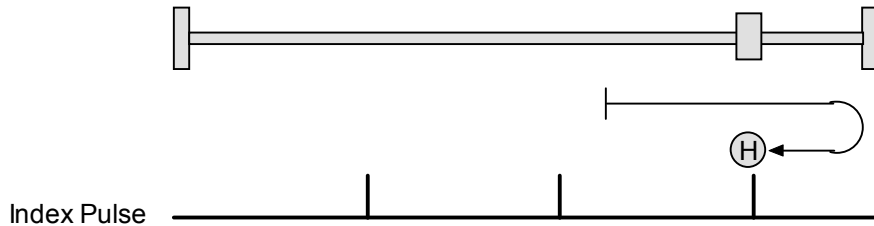

Direction of Motion: Negative

Home is the first index pulse on the positive side of the negative hard stop. Initial direction of motion is negative. The hard stop is reached when the amplifier outputs the homing Current Limit continuously for the amount of time specified in the Delay Time. If a negative limit switch is activated before the hard stop, an error is generated.

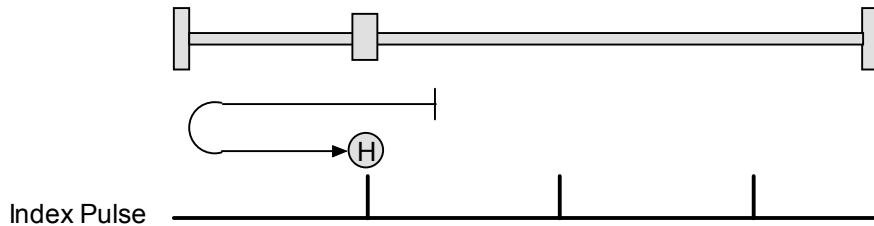

Hardstop Out to Index Methods in Stepper Mode

In Stepnet amplifiers operating in stepper mode with an encoder, the hard stop is reached when the following error is exceeded. When using hardstop methods in stepper mode, do not disable following error.

E.3.7: Home Switch

Direction of Motion: Positive

Home is the home switch transition. Initial direction of motion is positive if the home switch is inactive. If a limit switch is activated before the home switch transition, an error is generated.

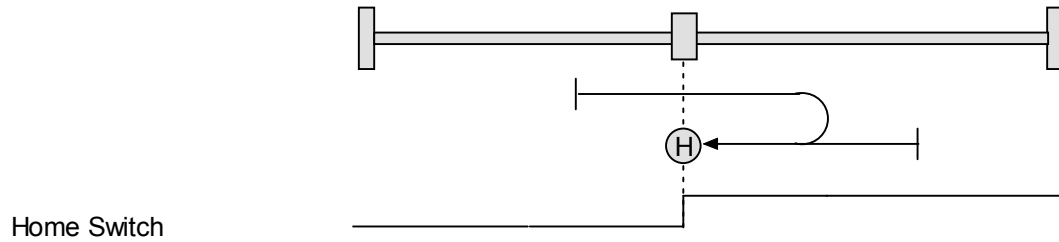

Direction of Motion: Negative

Home is the home switch transition. Initial direction of motion is negative if the home switch is inactive. If a limit switch is activated before the home switch transition, an error is generated.

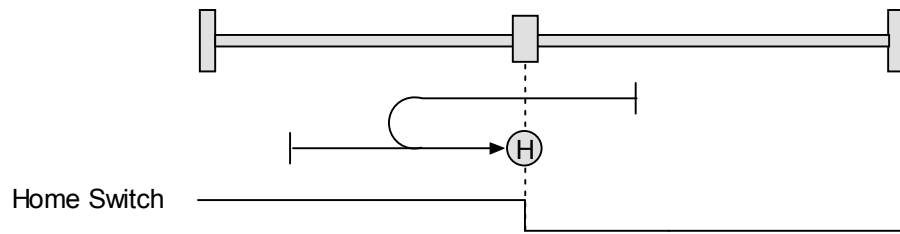

E.3.8: Home Switch Out to Index

Direction of Motion: Positive

Home is the first index pulse to the negative side of the home switch transition. Initial direction of motion is positive if the home switch is inactive. If a limit switch is activated before the home switch transition, an error is generated.

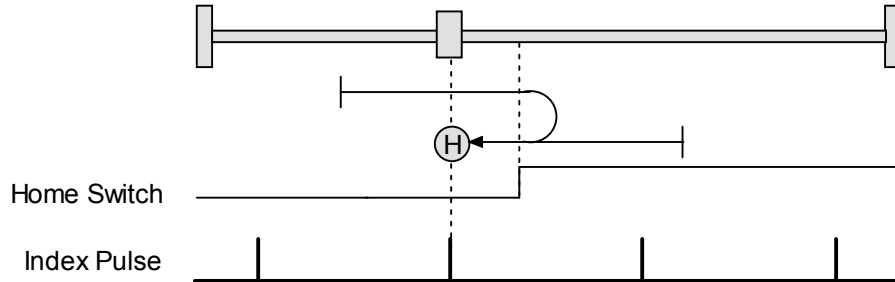

Direction of Motion: Negative

Home is the first index pulse to the positive side of the home switch transition. Initial direction of motion is negative if the home switch is inactive. If a limit switch is activated before the home switch transition, an error is generated.

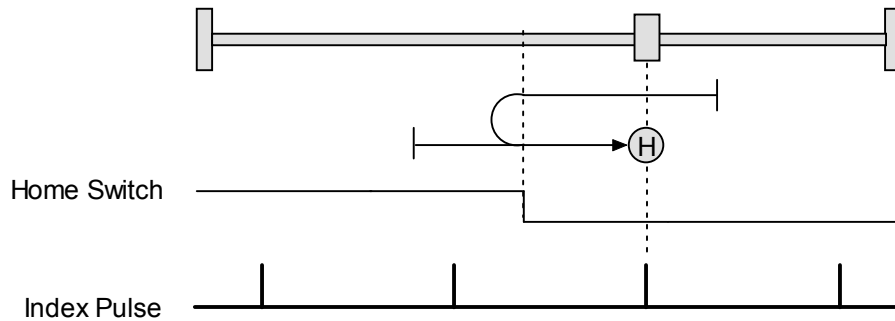

E.3.9: Home Switch In to Index

Direction of Motion: Positive

Home is the first index pulse to the positive side of the home switch transition. Initial direction of motion is positive if the home switch is inactive. If a limit switch is activated before the home switch transition, an error is generated.

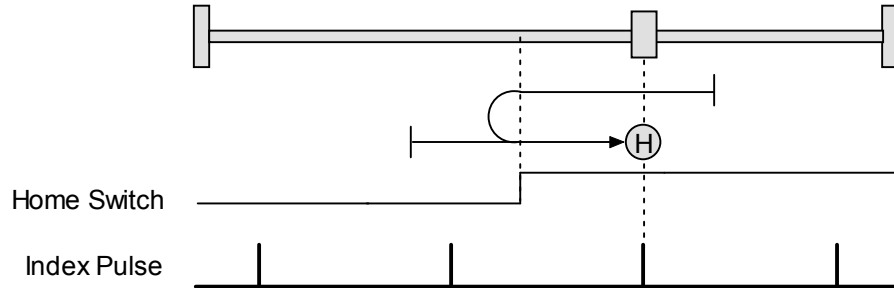

Direction of Motion: Negative

Home is the first index pulse to the negative side of the home switch transition. Initial direction of motion is negative if the home switch is inactive. If a limit switch is activated before the home switch transition, an error is generated.

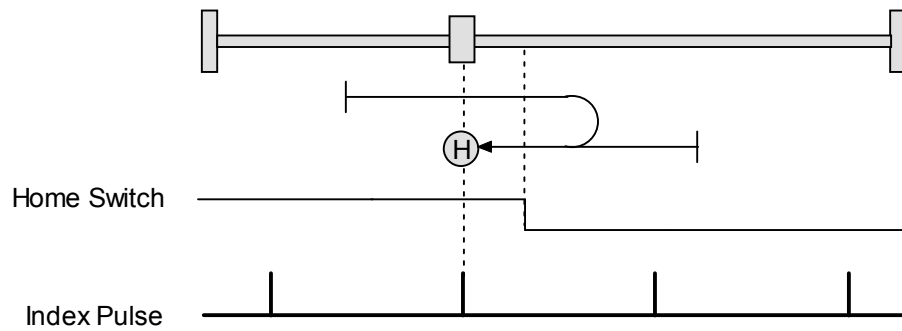

E.3.10: Lower Home

Direction of Motion: Positive

Home is the negative edge of a momentary home switch. Initial direction of motion is positive if the home switch is inactive. Motion will reverse if a positive limit switch is activated before the home switch; then, if a negative limit switch is activated before the home switch, an error is generated.

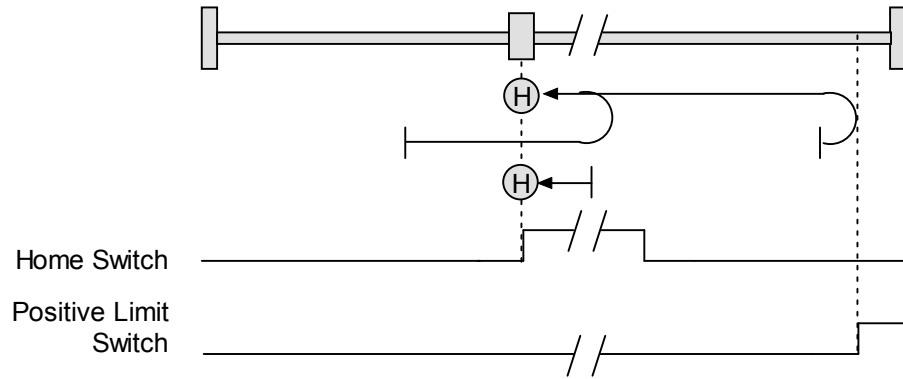

Direction of Motion: Negative

Home is the negative edge of a momentary home switch. Initial direction of motion is negative. If the initial motion leads away from the home switch, the axis reverses on encountering the negative limit switch; then, if a positive limit switch is activated before the home switch, an error is generated.

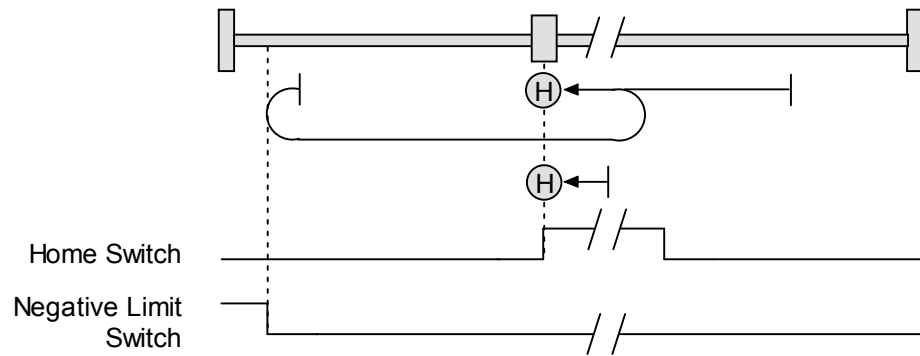

E.3.11: Upper Home

Direction of Motion: Positive

Home is the positive edge of a momentary home switch. Initial direction of motion is positive. If the initial motion leads away from the home switch, the axis reverses on encountering the positive limit switch; then, if a negative limit switch is activated before the home switch, an error is generated.

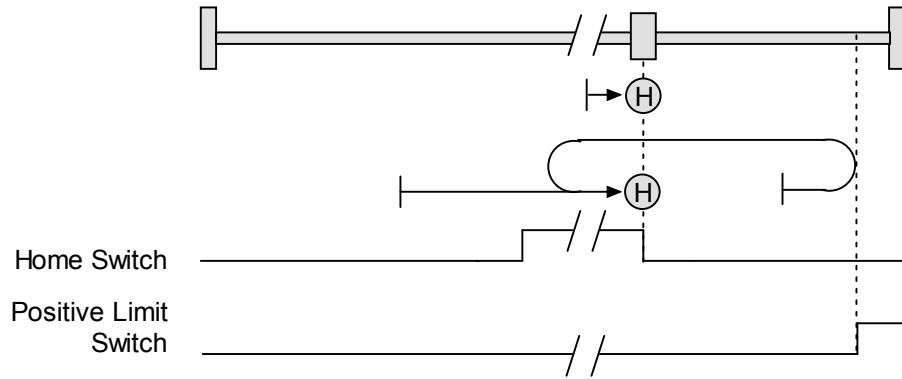

Direction of Motion: Negative

Home is the positive edge of momentary home switch. Initial direction of motion is negative if the home switch is inactive. If the initial motion leads away from the home switch, the axis reverses on encountering the negative limit switch; then, if a positive limit switch is activated before the home switch, an error is generated.

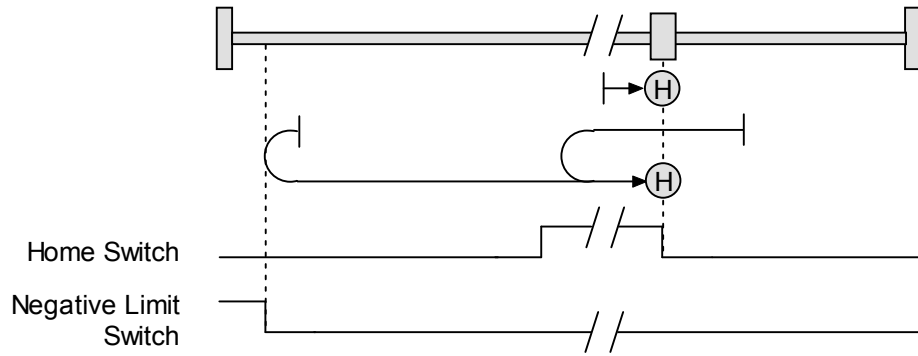

E.3.12: Lower Home Outside Index

Direction of Motion: Positive

Home is the first index pulse on the negative side of the negative edge of a momentary home switch. Initial direction of motion is positive if the home switch is inactive. If the initial motion leads away from the home switch, the axis reverses on encountering the positive limit switch; then, if a negative limit switch is activated before the home switch, an error is generated.

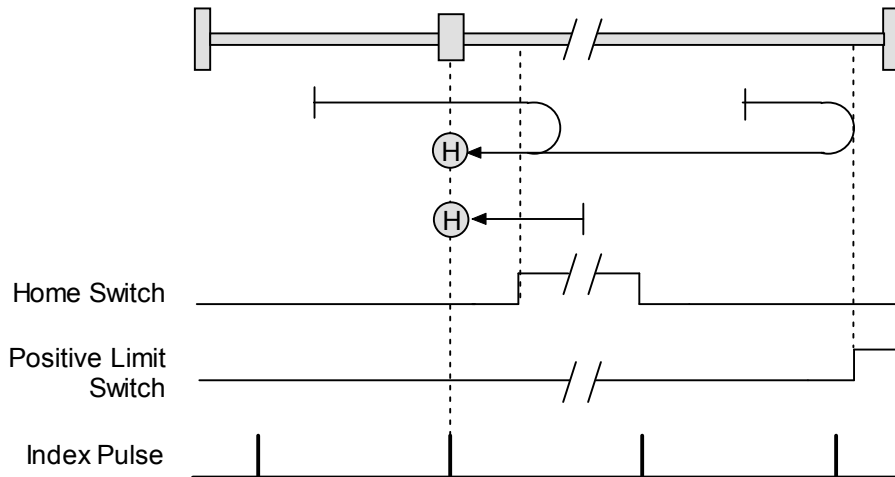

Direction of Motion: Negative

Home is the first index pulse on the negative side of the negative edge of a momentary home switch. Initial direction of motion is negative. If the initial motion leads away from the home switch, the axis reverses on encountering the negative limit switch; then, if a negative limit switch is activated before the home switch, an error is generated.

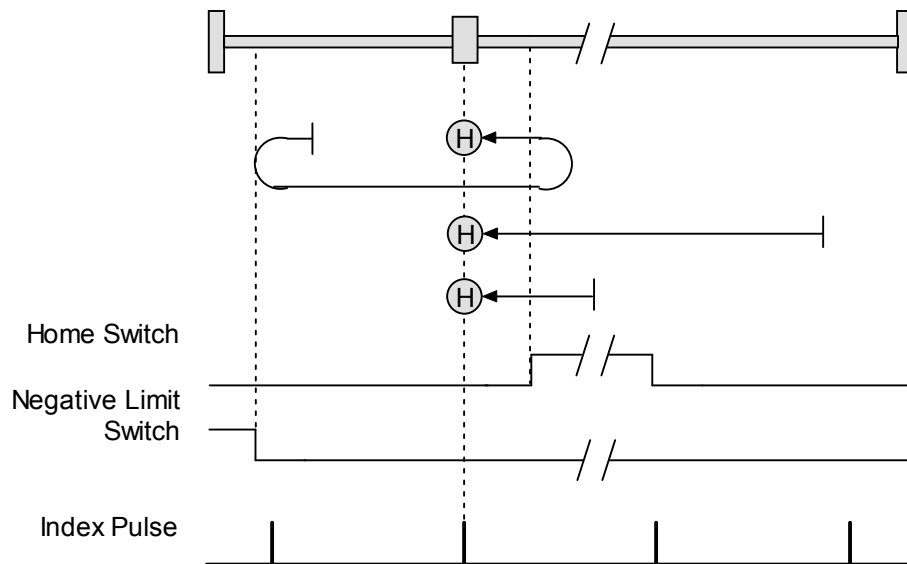

E.3.13: Lower Home Inside Index

Direction of Motion: Positive

Home is the first index pulse on the positive side of the negative edge of a momentary home switch. Initial direction of motion is positive if the home switch is inactive. If the initial motion leads away from the home switch, the axis reverses on encountering the positive limit switch; then, if a negative limit switch is activated before the home switch, an error is generated.

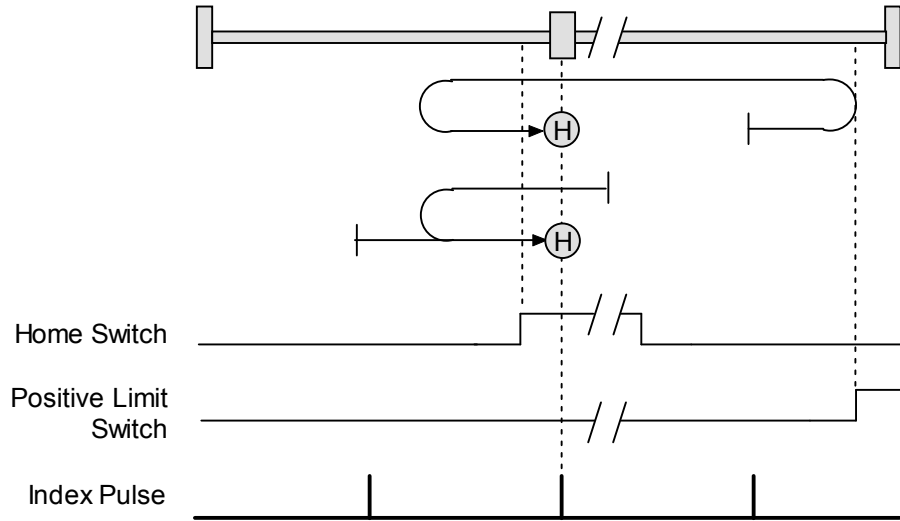

Direction of Motion: Negative

Home is the first index pulse on the positive side of the negative edge of a momentary home switch. Initial direction of motion is negative. If the initial motion leads away from the home switch, the axis reverses on encountering the negative limit switch; then, if a negative limit switch is activated before the home switch, an error is generated.

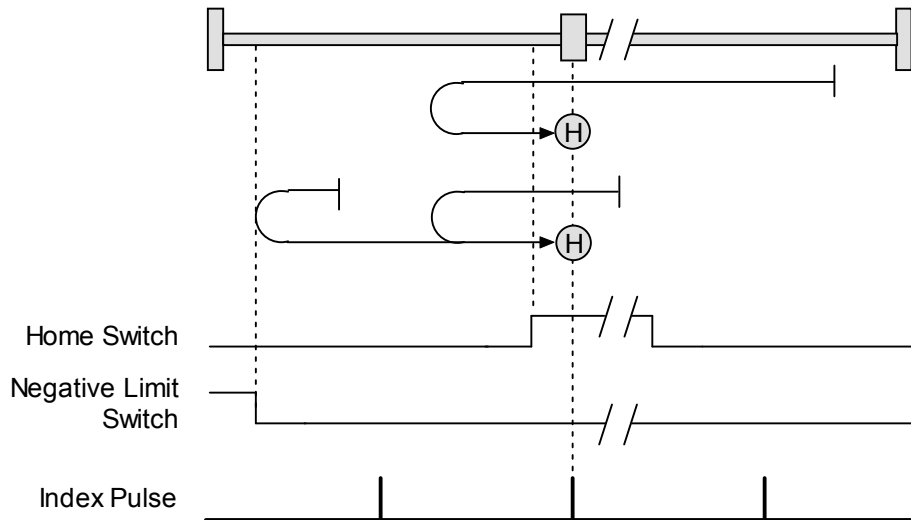

E.3.14: Upper Home Outside Index

Direction of Motion: Positive

Home is the first index pulse on the positive side of the positive edge of a momentary home switch. Initial direction of motion is positive. If the initial motion leads away from the home switch, the axis reverses on encountering the positive limit switch; then, if a negative limit switch is activated before the home switch, an error is generated.

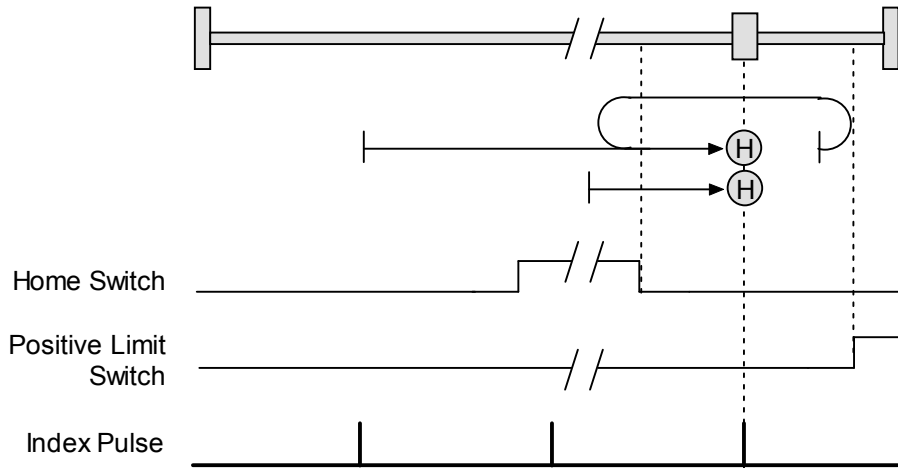

Direction of Motion: Negative

Home is the first index pulse on the positive side of the positive edge of a momentary home switch. Initial direction of motion is negative if the home switch is inactive. If the initial position is right of the home position, the axis reverses on encountering the home switch.

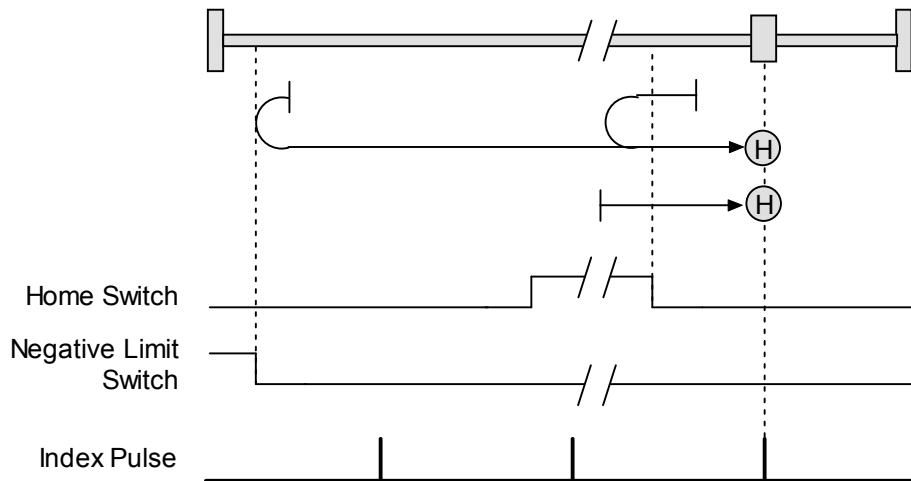

E.3.15: Upper Home Inside Index

Direction of Motion: Positive

Home is the first index pulse on the negative side of the positive edge of momentary home switch. Initial direction of motion is positive. If initial motion leads away from the home switch, the axis reverses on encountering the positive limit switch; then, if a negative limit switch is activated before the home switch, an error is generated.

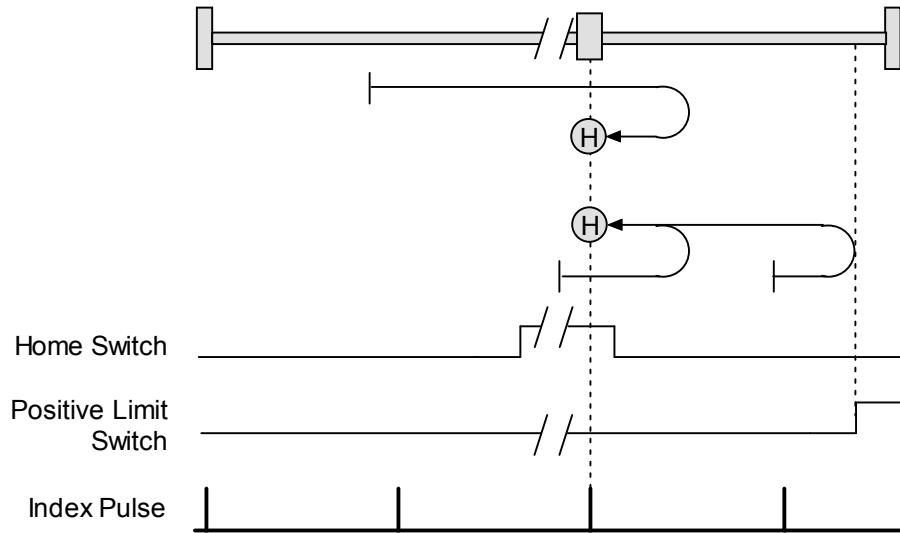

Direction of Motion: Negative

Home is the first index pulse on the negative side of the positive edge of a momentary home switch. Initial direction of motion is negative if the home switch is inactive. If initial motion leads away from the home switch, the axis reverses on encountering the negative limit; then, if a negative limit switch is activated before the home switch, an error is generated.

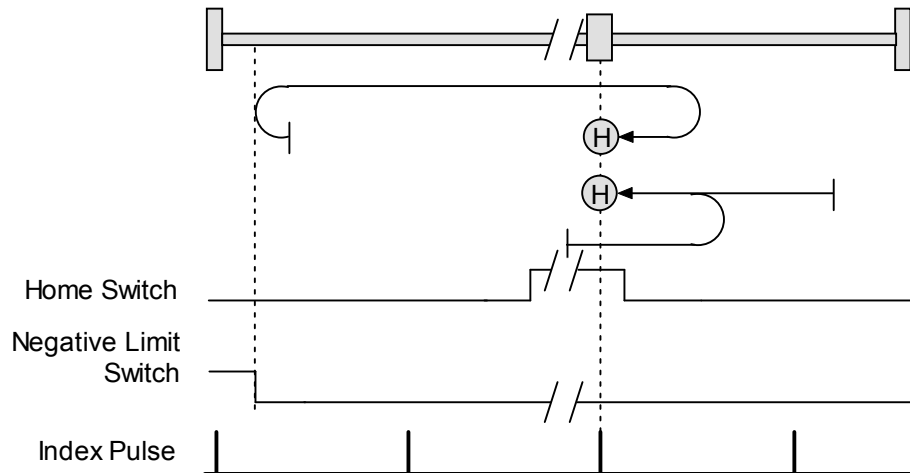

APPENDIX

F: REGEN RESISTOR CONFIGURATION

Optionally configure a regen resistor. Details follow in the chapter.



WARNING

Incorrect values may damage amplifier or external regen resistor.

For the regen I²T algorithms to work correctly, the values entered in the following steps must be correct. Damage to the external regen resistor may result from incorrect values entered. Damage to the amplifier may result if an incorrect resistance value is entered.

Failure to heed this warning can cause equipment damage.

Configure a Custom Regen Resistor

- 1  Click **Regen Settings** to open the *Regen Settings* screen.

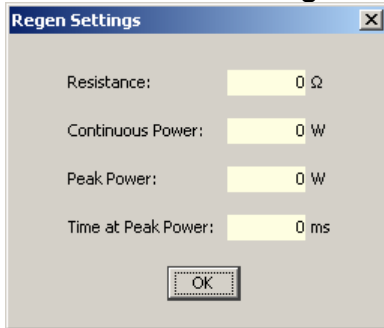

The image shows a screenshot of the 'Regen Settings' dialog box. The dialog has a title bar with 'Regen Settings' and a close button. Inside, there are four input fields: 'Resistance:' with a value of '0 Ω', 'Continuous Power:' with a value of '0 W', 'Peak Power:' with a value of '0 W', and 'Time at Peak Power:' with a value of '0 ms'. Below these fields is an 'OK' button.

- 2 If configuring a standard Copley Controls regen resistor, select the model number and click **Finish** to save the configuration and close the screen.

Otherwise, continue.

- 3 Enter appropriate values for Resistance, Continuous Power, Peak Power, and Time at Peak Power.
 - 4 Click **OK** to save the configuration and close the screen.
-

APPENDIX

G: ASCII COMMANDS/SERIAL CONTROL

This chapter describes how to configure and operate an amplifier by sending ASCII commands over the serial bus. Contents include:

[The Copley ASCII Interface \(p. 190\).](#)

[CME 2 ASCII Command Line Interface Tool \(p. 190\).](#)

[Single-Axis Serial Connection \(p. 191\).](#)

[Multi-Drop Serial Connection \(p. 191\).](#)

COMPATIBILITY: This chapter applies to Accelnet, Xenus, and Stepnet amplifiers only.

G.1: Copley ASCII Interface

An amplifier's RS-232 serial bus can be used by an external control application (HMI, PLC, PC, etc.) for setup and direct serial control of the amplifier. The control application can issue amplifier commands from the set of ASCII format commands that make up the Copley Controls ASCII Interface.

For more information, see the *Copley ASCII Interface Programmer's Guide*.

G.2: CME 2 ASCII Command Line Interface Tool

As described below, the CME 2 ASCII Command Line Interface tool provides a simple way to enter Copley ASCII commands.

Use the ASCII Command Line Interface to Enter Commands

- 1 From the Main screen, choose **Tools**→**ASCII Command Line** to open the tool.

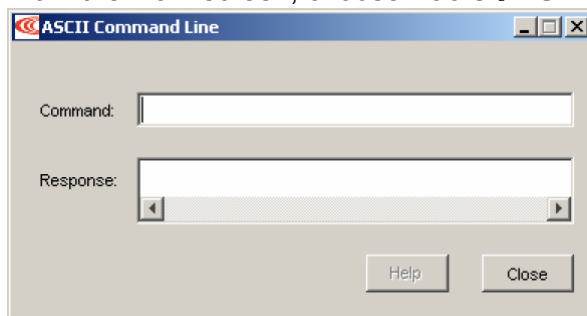

- 2 Enter an ASCII Command in the *Command* field.
- 3 Press the **Enter** key to send the command to the amplifier. Observe the *Response* field. If a value is returned, it is preceded by the letter "v." In the following example, the get command was used to retrieve the amplifier RAM value of variable 0x32 (actual position).

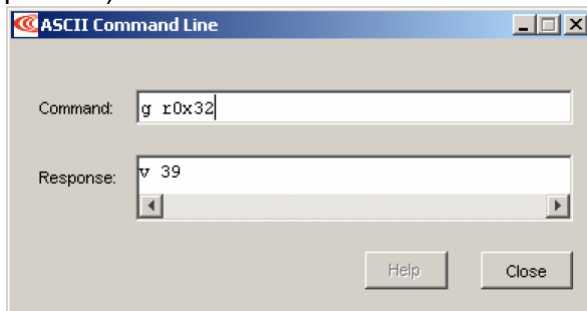

An error code would be preceded by the letter "e."

TIP: To view an error definition, hold the mouse pointer over the error number.

For more information, see the *Copley ASCII Interface Programmer's Guide* and the *Copley Amplifier Parameter Dictionary*.

G.3: Single-Axis Serial Connection

For RS-232 serial bus control of a single axis, set the CAN node address of that axis to zero (0). Note that if the CAN node address is switched to zero after power-up, the amplifier must be reset or power cycled to make the new address setting take effect.

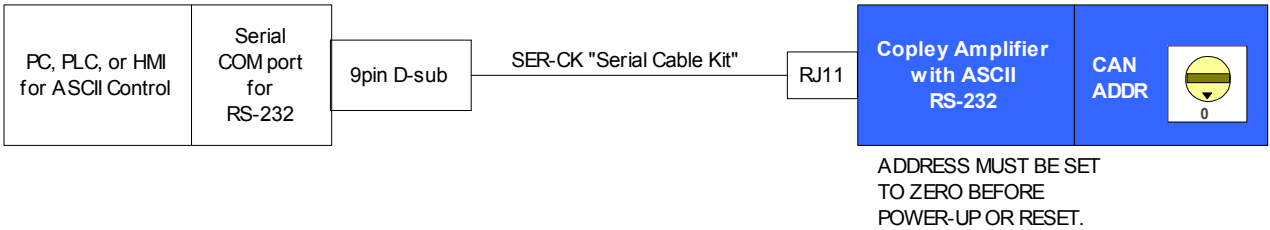

G.4: Multi-Drop Serial Connection

A serially connected amplifier can be used as a multi-drop gateway for access to other amplifiers linked in a series of CAN bus connections. Set the CAN node address of the serially connected amplifier (gateway) to zero (0). Assign each additional amplifier in the chain a unique CAN node address value between 1 and 127. For more information on CAN node address assignment, see [CAN Network Configuration \(p. 67\)](#). Use 120 Ohms termination on the first and last amplifier.

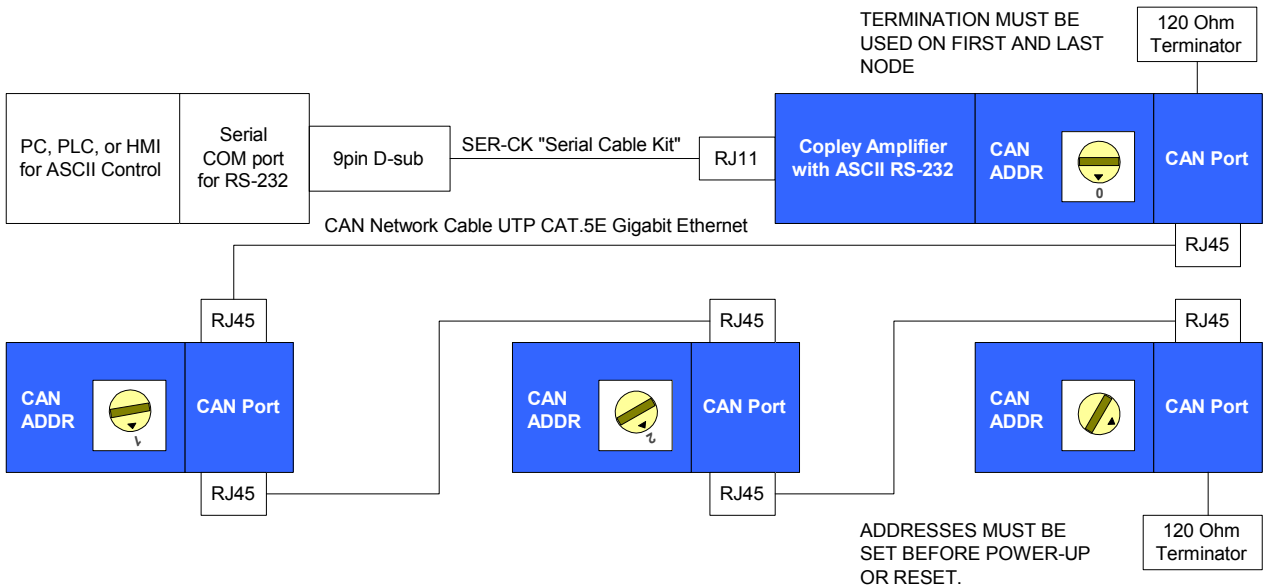

APPENDIX

H: GAIN SCHEDULING

The *Gain Scheduling* feature allows you to schedule gain adjustments based on changes to a key parameter. For instance, P_p , V_p , and V_i could be adjusted based on changes to commanded velocity.

Gain adjustments are specified in a Gain Scheduling Table. Each table row contains a key parameter value and the corresponding gain settings. The amplifier uses linear interpolation to make smooth gain adjustments between the programmed settings.

Gain scheduling involves the basic steps outlined below. Details follow in the chapter.

[Configure Gain Scheduling \(p. 194\)](#)

[Set Up the Gain Scheduling Table\(s\) \(p. 195\)](#), observing the [Gain Scheduling Table Guidelines](#)(p. 199)

H.1: Configure Gain Scheduling

Use this procedure to select basic Gain Scheduling options.

- 1 If necessary, [Start CME 2 Software \(p. 13\)](#).
- 2 On the *Main* screen, choose **Amplifier→Gain Scheduling**.

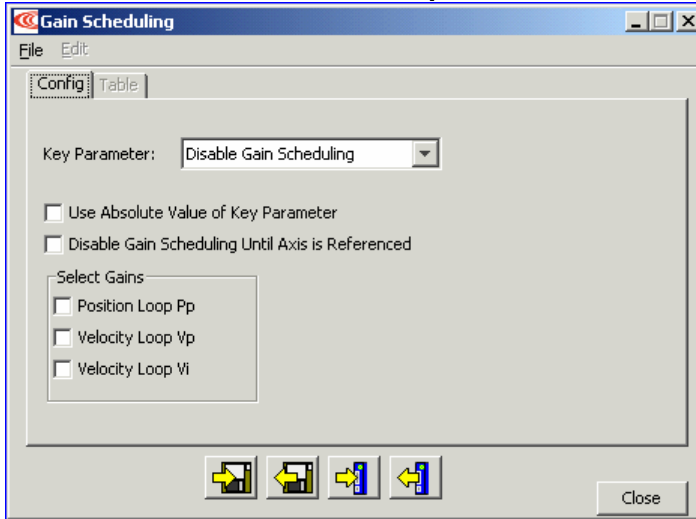

- 3 Choose the Key Parameter:

Key Parameter	Description
Disable Gain Scheduling.	Disable gain scheduling.
Use Written Parameter.	An external controller can write to this parameter using any of several protocols and corresponding parameter IDs: Copley ASCII Interface or the Copley Indexer 2 Program (ID 0x128), CANopen and EtherCat (Index 0x2371), DeviceNet (object ID 0x2372), and MACRO I-variable (0x528). See the <i>Copley ASCII Interface Programmer's Guide</i> , the <i>Copley Indexer 2 Program User Guide</i> , the <i>Copley CANopen Programmer's Guide</i> , or the <i>Copley DeviceNet Programmer's Guide</i> .
Use Commanded Velocity.	Schedule gain adjustments based on changes to commanded velocity.
Use Actual Velocity.	Schedule gain adjustments based on changes to actual velocity.
Use Commanded Position.	Schedule gain adjustments based on changes to commanded position.
Use Actual Position.	Schedule gain adjustments based on changes to actual position.

- 4 Optionally set controls:

Control	Description
Use Absolute Value of Key Parameter	If a velocity or position value is chosen for the Key Parameter and this option is set, the Key Parameter is interpreted as an absolute value.
Disable Gain Scheduling Until Axis is Referenced	When this option is set, the scheduled gain adjustments do not take place until the axis is referenced (homed).

- 5 Select the gains that you wish to adjust by schedule. The choices are Pp, Vp, and Vi. For each gain you select, a column will be enabled in the Gain Scheduling Table.
- 6 Continue with [Set Up the Gain Scheduling Table\(s\) \(p. 195\)](#).

H2: Set Up the Gain Scheduling Table(s)

H.2.1: Create a Gain Scheduling Table

- 1 If necessary, [Start CME 2 Software \(p. 13\)](#).
- 2 On the *Main* screen, choose **Amplifier**→**Gain Scheduling**.
- 3 On the *Gain Scheduling* screen, open the *Table* tab:

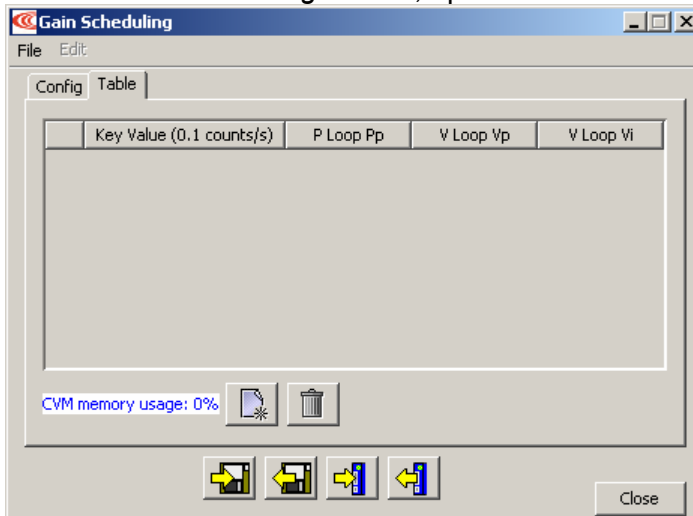

If there is a table stored in amplifier flash, the screen will show it as in this sample:

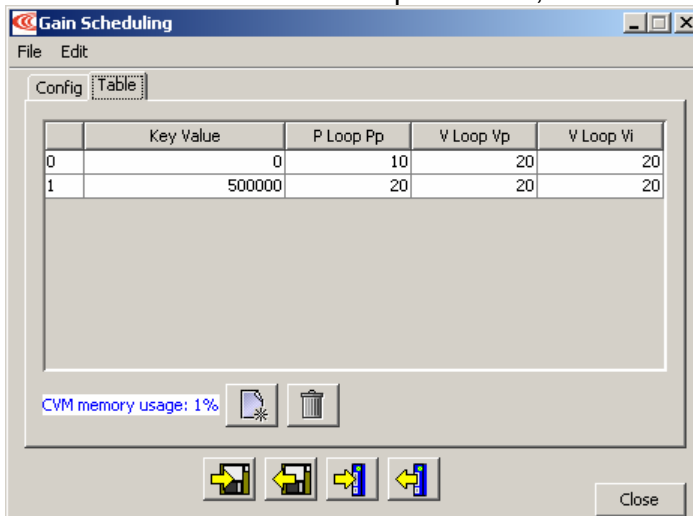



- 4  If there is already a table stored in flash: Optionally [Save Settings and Table Data to Disk \(p. 197\)](#).

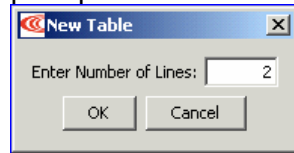

Then click the **Delete** tool to delete the gain scheduling table data from amplifier flash and PC RAM.

- 5  On the Table tab, click the **Create a new gain scheduling table** tool. See the prompt:



- 6 Enter the number of lines (the number of gain adjustment specifications). Click **OK**.
- 7 Enter the Key Parameter and gain adjustment values. All values must be integer, and each Key Parameter value must be greater than the previous as described in [Gain Scheduling Table Guidelines \(p. 199\)](#). Click in a field to enter or modify a value. Standard mouse and keyboard editing techniques are available.
- 8  On the Table tab, click **Save gain scheduling table and setup to amplifier flash memory** before attempting to run the new table. This saves the *Table* tab data and all *Config* tab settings.
- 9 **Close** the screen.
-

H.2.2: Edit Gain Scheduling Table Values

- 1 If necessary, [Start CME 2 Software \(p. 13\)](#).
- 2 On the *Main* screen, choose **Amplifier**→**Gain Scheduling**.
- 3 On the *Gain Scheduling* screen, open the *Table* tab:

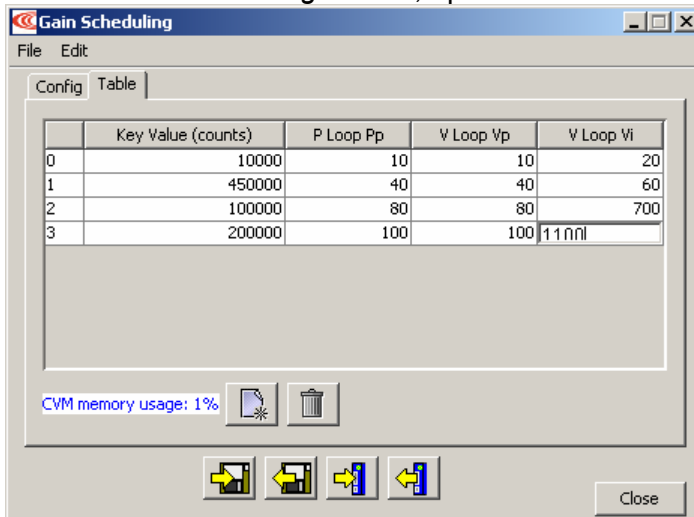

- 4 Edit using standard keyboard and mouse techniques. Note that if you begin typing immediately, the digits you enter will be inserted in front of any existing digits.



All values must be integer, and each Key Parameter value must be greater than the previous as described in [Gain Scheduling Table Guidelines \(p. 199\)](#).

- 5  On the Table tab, click **Save gain scheduling table and setup to amplifier flash memory** before attempting to run the new table. This saves the *Table* tab data and all *Config* tab settings.
- 6 **Close** the screen.



H.2.3: Save and Restore Gain Scheduling Tables and Settings

The *Config* tab settings and *Table* tab data can be saved to a Copley Controls gains file (filename extension .cgg) on disk. A .cgg file can be restored and then saved to flash.

Save Settings and Table Data to Disk

- 1  On the *Gain Scheduling* screen, click the **Save gain scheduling table and setup to disk** tool to open the *Save Table to Disk* screen. Enter a name for the file, and click **Save**. *Config* tab settings and *Table* tab data are saved to the file.
 - 2  Click **Save gain scheduling table and setup to amplifier flash memory** before attempting to run the new table. This saves the *Table* tab data and all *Config* tab settings to amplifier flash.
 - 3 **Close** the screen.
-

Restore Settings and Table Data from Disk

- 1** Set Up the Gain Scheduling Table(s) (p. 195) or Edit Gain Scheduling Table Values (p. 197). Observe the [Gain Scheduling Table Guidelines](#) (p. 199).
- 2**  On the *Gain Scheduling* screen, click the **Restore gain scheduling table and setup from disk** tool to open the *Restore Gain Scheduling Table from Disk* screen. Highlight the name of the file containing the settings and data you wish to restore, and click **Open**. The settings and data are restored to the *Config* and *Table* tabs.
- 3**  Click **Save gain scheduling table and setup to amplifier flash memory** before attempting to run the new table with the new settings. This saves all *Config* tab settings and *Table* tab data to amplifier flash.
- 4** **Close** the screen.

H.3: Gain Scheduling Table Guidelines

A Gain Scheduling Table contains a progression of Key Parameter values and corresponding gain adjustment values.

H.3.1: Gain Schedule Table Storage Limits

The maximum number of lines (gain adjustment specifications) that can be stored in the Gain Scheduling Table is 1000. A typical Gain Schedule Table will contain far fewer lines.

The number of Gain Scheduling Table lines is limited by the amount of CVM memory space available in the amplifier. A Gain Scheduling Table loaded into the amplifier shares that space with Copley Virtual Machine (CVM) programs and Camming Tables. Therefore, the maximum number of Gain Schedule Table lines will decrease if CVM programs or Camming Tables are stored in the amplifier.

The *Gain Scheduling* screen *Tables* tab displays the percentage of amplifier memory used:



H.3.2: Gain Schedule Data Rules

- All must be whole numbers (no fractional values).
- All Key Values must be increasing.

CME 2 User Guide
P/N CC95-00454-000
Revision A
June 2009

© 2006, 2007, 2008, 2009
Copley Controls
20 Dan Road
Canton, MA 02021 USA
All rights reserved